



Sunsport 20V



Sunsport 22V



Launch 21V



Launch 22V



Launch 242

SUPRA
A BETTER WAKE. A BETTER BOAT.

Boat Information

Hull Identification Number: _____

Date of Purchase: _____

Dealership: _____

Dealer's Phone Number: _____

Registration Number: _____

Engine Serial Number: _____

Trailer Serial Number: _____



SKIER'S CHOICE, INC.

1717 Henry G. Lane Street
Maryville, Tennessee 37801

Trademarks

Supra, the Supra Logo, Sunsport 20V, Sunsport 22V, Launch 21V, Launch 242V are registered trademarks of Skier's Choice, Inc.
All other product names are copyright and registered trademarks/trade names of their respective owners.

Skier's Choice, Inc. reserves the right to change product specifications at any time without incurring obligation.

©2012 Skier's Choice, Inc.

Introduction

Supra inboard ski boats are manufactured by Skier's Choice, Inc. in Maryville, Tennessee and distributed throughout the United States and the world.

This manual provides an overview for operating your Supra boat. It should be considered a permanent part of your Supra boat, and contains important information on Safety, Boating Rules, Proper Operation and Maintenance of your boat. Should the boat be sold, this manual will provide the same important information to the next owner.

Be sure to read and understand all aspects of Boating Safety and Operation before using your boat. If you have any questions, your dealer can provide the information you need to have a safe and pleasurable boating experience.

All information, illustrations and specifications in this manual are based on the latest product information available at the time of printing. Supra may discontinue models and equipment or change specifications and designs without any notice and without incurring obligation.

This manual contains information about several Supra models. Some information may not apply to your boat since standard and optional equipment may vary from model to model.

As you read through this manual, you will find **CAUTION**, **WARNING** and **DANGER** symbols which require special attention. Please read them carefully! They may tell you how to avoid problems and/or endangering yourself, your passengers, and other boaters. **PLEASE REVIEW ALL SAFETY INFORMATION.**



A maintenance schedule and accessory information are included to assure trouble-free operation of your boat. Should service problems arise, remember that your Supra dealer knows your boat best and is interested in your total satisfaction.

Thank you for purchasing a Supra boat. We hope your ownership results in an enjoyable and rewarding boating experience. Be safe and enjoy the fun!

SUPRA
A BETTER WAKE. A BETTER BOAT.



Daily Checklist

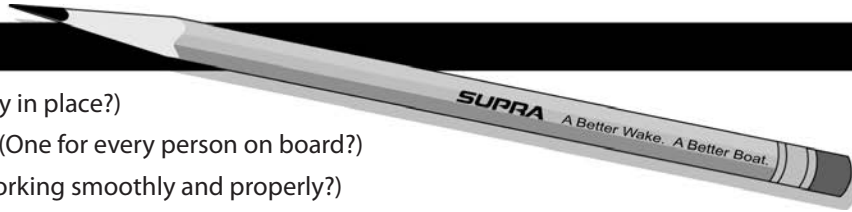

- Drain Plugs (Securely in place?)
- Life-Saving Devices (One for every person on board?)
- Steering System (Working smoothly and properly?)
- Fuel System (Adequate fuel? Leaks? Fumes?)
- Battery (Fully charged? Cable terminals clean and tight?)
- Engine (In Neutral?)
- Capacity Plate (Are you overloaded or overpowered?)
- Weather Conditions (Safe to go out?)
- Electrical Equipment (Lights, horn, blower, bilge pump, etc.?)
- Emergency Gear (Fire extinguisher, bailer, paddle, anchor & line, signaling device, tool kit, etc.?)
- Bilge Pump (Working properly?)

NOTE: Bilge pump should be checked prior to each use to ensure proper operation!

Check **BEFORE** running (where applicable)

- Engine Oil level
- Transmission Lubricant level
- Engine Drain Plug, Transom Drain Plug and Center Drain Plug
- Leakage (Fuel, water lines and connections)

CAUTION

DO NOT operate engine without cooling water flowing through water pump, otherwise pump will sustain damage and subsequent engine damage may result!

Check **BEFORE** running

- Oil Pressure: Refer to Engine Owner's Manual
- Water Temperature: 160 degrees to 180 degrees for raw water systems (water is not recirculated), and 180 degrees to 200 degrees for closed cooling systems (water is recirculated).
- Idle RPM: (650-750) in gear.
- Maximum Forward RPM: See Engine Owner's Manual.
- Shifting Linkage (Forward, Neutral and Reverse).

WARNING

- **GASOLINE VAPORS CAN EXPLODE! It is very important to check for fuel spillage or leaks prior to each use of your boat.**
- Check engine compartment for gasoline vapors.
- Operate blower for 4 minutes before starting the engine.
- Always operate blower below cruising speed.
- **NOTE: Please refer to your Engine Owner's Manual for maximum RPM and engine break-in procedure.**



Important Safety Information!

Your safety, as well as the safety of others with and around you, is a direct result of how you operate and maintain your boat. Read and comprehend this manual. Make sure that you understand all the controls and operating instructions before attempting to operate the boat. Improper operation is extremely dangerous.

The basic safety rules are outlined in this section of the manual. Additional precautions throughout the manual are noted by the following symbols:

CAUTION

This symbol indicates a potentially hazardous circumstance, which, if not avoided, may result in *minor or moderate injury*. It may also be used to alert against unsafe practices.

WARNING

This symbol indicates a potentially hazardous situation, which, if not avoided, could result in *death or serious injury*.

DANGER

This symbol indicates an imminently hazardous situation, which, if not avoided, will result in death or serious injury. This is limited to the most extreme situations.

The precautions listed in this manual and on the boat are not exhaustive. If a procedure, method, tool or part is not specifically recommended by Skier's Choice, you must satisfy yourself that it is safe for you and others, and that the boat will not be damaged or made unsafe as a result of your decision.

REMEMBER: ALWAYS USE COMMON SENSE WHEN OPERATING, SERVICING OR REPAIRING THE BOAT!

In addition to everyday safety, failure to observe safety recommendations may result in severe personal injury or death to you or to others. Use caution and common sense when operating your boat. Don't take unnecessary chances!

Be certain that all boat passengers are aware of this information and conform to boat safety principles.

Safe Boating

Safe boating practices may seem obvious, but people have thought up risky and dangerous activities in boats, with boats, and behind boats. Just because you or your passengers have seen a boating maneuver performed or have seen a particular activity promoted, do not assume there is no risk of injury or death. Before you or your passengers go out in the boat and engage in any water sport activity, give careful consideration to the risks. Plan ahead. Think twice before you try something new behind your boat or with your boat. Know the limits of you, your passengers and your equipment and do not exceed them.

In addition to careful review of this manual, you should be aware as well that there are many sources of information available. Skier's Choice urges you to pursue additional training, such as safety and seamanship courses offered by the U.S. Coast Guard Auxiliary and the U.S. Power Squadron.

Safe boating and safe actions may seem obvious, yet every year US Coast Guard statistics give evidence that many people disregard safe boating practices. Do not take safety for granted. Think twice. We want all our boat owners and their passengers, friends, and families to have a safe and enjoyable experience on the water.

US Coast Guard Auxiliary Boating Safety Course

The purchaser of a new 2012 Supra boat is entitled to a USCGA Boating Safety Course that Supra will pay for. Please see the Certificate in your owner's packet or your dealer for more details.

Water Sports Names and Terminology

There are many types of towed water sports, and they are known by many different names. The more popular sports are wakeboarding, waterskiing, surfing, wakeskating and tubing. And there are many others. The terms used to describe participants in towed water sports activities also vary greatly. Typical terms include rider, skier, and wakeboarder. To keep the language in this manual straightforward, we use rider or skier to refer to a participant in any towed water sport. The terms ski, skiing, riding or wakeboarding are used to refer to any towed water sport.

Safety Training Organizations

The following is a listing of just some of the agencies and organizations that offer safety training or information:

American Red Cross, National HQ

2025 E Street NW, Washington, DC 20006
(202) 303-4498 www.redcross.org

USA Waterski

1251 Holy Cow Rd., Polk City, FL 33868
(863) 324-4341 www.usawaterski.org

Boat Owners Association of the United States (BOAT/US)

880 South Pickett Street, Alexandria, VA 22304
(703) 461-4666 www.boatus.com

National Safe Boating Council

P.O. Box 509, Bristow, VA 20136
(703) 361-4294 www.safeboatingcouncil.org

U.S. Coast Guard Auxiliary Public Relations Center

9449 Watson Industrial Park, St. Louis, MO 63126
(877) 875-6296 www.cgaux.org

U.S. Power Squadron

P.O. Box 30423, Raleigh, NC 27622
(888) 367-8777 www.usps.org

On-Line Basic Boating Safety Course

www.boatsafe.com

National Marine Manufacturers Association

231 S. LaSalle Street, Suite 2050, Chicago, IL 60604
(312) 946-6200 www.nmma.org

Federal law requires certain safety equipment to be onboard at all times. In addition, responsible boaters carry other equipment in case of emergency. Check with the local boating authorities for any additional requirements over and above the federal stipulations.

Safety Equipment

Your Supra has been equipped at the factory with most of the federally required safety equipment for inland waters (Class 1, 16'-to-26'). This equipment includes:

- UL-approved Marine Fire Extinguisher, Type A-BC (2 lbs.), good for solids, liquids, and electrical fire
- ABYC-approved Marine Mufflers with water injection
- USCG-approved Marine Flame Arrestor
- USCG-approved Engine Box Ventilation with sparkless power blower
- ABYC-approved Electric Horn sound warning device
- USCG-approved inland lighting

Federal law also requires at least one Type I, II or III Personal Flotation Device (PFD) for each person on board or being towed on water skis or other recreational equipment. In addition, one throwable Type IV PFD must also be on board. As the owner, obtaining the appropriate PFDs is your responsibility. Your Supra dealer can and will be happy to assist you.

NOTE: Requirements for coastal waters and inland waters differ. Check with the local authorities for more information.

A smart owner will avoid potential problems on an outing by having additional equipment on board. Normally, this equipment is dependent on the body of water and the length of the trip.

We suggest the following—as a minimum. Your Supra dealer can also assist you with additional recommendations.

- An anchor with at least 75 feet of line
- A manual bailing device for removing water
- A combination oar/boat hook
- A day-and-night visual distress signal
- A first aid kit and manual
- An airway breathing tube
- A waterproof flashlight
- A set of local navigation charts
- Mooring lines and fenders
- Extra engine oil
- A tool kit
- A portable AM/FM radio or weather radio
- VHF hand held marine radio

Boating-related accidents are generally caused by the operator's failure to follow basic safety rules or written precautions. Most accidents can be avoided if the operator is completely familiar with the boat, its operation, and can recognize potentially hazardous situations before an accident occurs.



General Safety Precautions

Failure to adhere to these precautions may result in severe injury or death to you and/or others.

WARNING

- Improper operation is extremely dangerous. Operators must read and understand all operating manuals supplied with the boat before operation.
- Remain seated at all times while the boat is in motion.
- Never stand or allow passengers to stand while the boat is moving. You or others may be thrown from the boat.
- Children in the bow of the boat should be accompanied by an adult at all times.
- Never operate the boat while under the influence of alcohol or drugs.
- On-board equipment must always conform to the governing federal, state, and local regulations.
- Gasoline vapors can explode. Before starting engine, open engine box, check engine compartment for gasoline vapors, and operate blower for at least four minutes. Run blower below cruising speed.
- Leaking fuel is a fire and explosion hazard. Inspect system regularly. Examine fuel tanks for leaks or corrosion at least annually.
- Never override or modify the engine safety shut-off switch or engine neutral starting safety switch in any way.
- Never remove or modify components of the fuel system in any way except for maintenance by qualified personnel. Tampering with fuel components may cause a hazardous condition.
- Never allow any type of spark or open flame on board. It may result in fire or explosion.
- It is the owner's responsibility to check tightness of the tower bolts BEFORE each use.
- The tower is designed to pull a single (1) individual. DO NOT climb or sit on the tower. Rope may loop on inverted tricks. DO NOT sit behind the pulling point of the tower.
- Comply with the capacity limits stated on the capacity warning label in the boat.

DANGER

- To avoid serious personal injury, DO NOT be on or about the swim platform while engine is running and keep away from rear of boat while engine is running.
- To avoid serious personal injury, DO NOT operate engine while anyone is on or about the swim platform or in the water near the boat.

General Safety Precautions *(continued)*

CAUTION

- The tow bar is not designed for vertical extensions. Any modifications to the tow bar or its mountings may result in damage to the boat and injury to the user.
- The tower may strike low objects. Check clearance height around docks, shore, overhanging objects, bridges and power lines.
- Do not pull past 45 degrees of the centerline of the boat. Failure to follow this rule could result in the boat capsizing.

CAUTION

- It is the driver's responsibility to ensure all passengers are seated when the boat is underway.

WARNING

Failure to adhere to these warnings may result in severe injury or death to you and/or others.

- This boat is a high-performance boat and capable of quick and tight turns and changes in direction. It is the driver's responsibility to operate the boat in a manner to ensure the safety of all passengers.

WARNING

Boaters must continuously be aware of weather conditions.

- Sudden storms, wind, lightning, etc., can unexpectedly put boaters in grave danger. Always check the local weather report before going boating.

DANGER

It is the driver's responsibility to determine if weather or other factors have created an unsafe boating environment.

The driver is solely responsible for the consequences of their actions.



Water Sports Safety

Riders are obligated to be as aware of the fundamental safety rules as well as the boat operator. If you are new to towed water sports, seek certified training before starting. You will find it especially helpful to join a local ski club and USA Waterski when possible.

Always remember that the majority of water sports injuries are the result of impacts with other objects, so always look where you are going and be aware of what is going on around you.

CAUTION

Failure to adhere to these warnings may result in severe injury or death to you and/or others.

- Every skier must always wear a USCG-approved personal flotation device.
- Maintain a distance of at least 100 feet from all other objects, including other boats, piers, rafts, mooring and navigational buoys, pilings, abutments, or any other items.
- Always have an experienced driver and observer in the boat when skiing.
- Never ski in shallow water, close to shore, or in water where you do not know the depth or what is beneath the surface.
- Never put your arm, head, or any other part of your body through the handle-bridle of the ski line nor wrap the line around any part of the body at any time.
- Never ski at night, or directly in front of other boats.
- Never jump from a boat that is moving at any speed, nor enter or exit the water when the engine is running (ON).
- Make sure that everyone knows and uses approved skiing hand signals and common skiing courtesies.

Carbon Monoxide (CO) Safety

DANGER

Carbon monoxide is a colorless, odorless and tasteless gas. It is produced by gasoline engines and is a component of exhaust fumes.

Shut off the engine when people are on the swim platform or in the water around the rear of the boat.

Do not do any other activities which puts people in close proximity of the transom when the engine is running.

For the most current information on carbon monoxide, you may call, write or visit on-line any of the following:

United States Coast Guard

Office of Boating Safety (CG-5422)
2100 Second Street SW STOP 7581,
Washington, DC 20593-7581
1-800-368-5647 www.uscgboating.org

NMMA

National Marine Manufacturers Association
231 S. LaSalle St., Suite 2050, Chicago, IL 60604
312-946-6200 www.nmma.org

American Boat & Yacht Council, Inc.

613 Third St., Suite 10, Annapolis, MD 21403
410-956-4460 www.abycinc.org

Product Misuse

Misuse of the product or use of it in a manner for which it was never intended can create dangerous situations. The driver and passengers are responsible for using the product safely and as intended. The driver must operate the boat in a manner that ensures the safety of all passengers. If you or your passengers are unsure about use of the product, about performing certain boating maneuvers or are unsure about a particular water activity, refer to this manual or contact a knowledgeable source such as your local dealer, Skier's Choice, Inc., the US Coast Guard, or your local boating authority.

Capacity and Weighting Your Boat

Do not exceed the capacity warning label affixed to the boat in the helm area. The capacity limit is shown in number of people and weight limit in pounds. Ballast and gear are included in the total limit and must be taken into account. This means when ballast is added to the boat, the capacity limit available for people is reduced by the amount of ballast added.

Although water intrusion and waves spilling inside a boat is an obvious boating hazard, this hazard can be increase when weighting your boat for water sports such as wakeboarding or wakesurfing. Do not overweight the boat or exceed boat capacity. Use good judgment when using unbalanced weight in your boat. Concentrating weight in a rear corner of the boat for wakesurfing puts the top of the deck closer to water level. Backwash, large waves and choppy water are more likely to swamp the boat in this situation. Excess weight in the bow of a boat can create the same hazard and also create unsafe steering conditions. Driver visibility can be reduced when using unbalanced weight. Use good judgment when weighting your boat for any towed water sports. Educate yourself on the proper responses for the differing unsafe situations you could encounter.



PROPER SEATING

When you apply proper seating to the bow area, it is likely to accommodate no more than 4 people. Keep in mind not to overweight the bow area relative to the cockpit area to avoid unsafe steering conditions and other hazards. See earlier section on Capacity and Weighting Your Boat.



The driver must be aware of all passenger's locations and positions, and passengers must stay alert to changes in direction.

The boat is capable of quick and tight turns. Such maneuvers can cause unseated occupants to be thrown around or out of the boat. Alert passengers before changes in direction.

Contact Information

If you have questions regarding the operation of your boat, accessory or options or questions in regard to Boat Safety, contact your dealer or Skier's Choice, Inc. at 865-983-9924.



Typical Warning Label Locations V-Drive Models

Warning labels are placed on your boat to alert you to potential hazards that may not be obvious. They also tell you how to avoid the hazard. Warning labels should never be removed and, if any label is damaged, it should be replaced as soon as possible.

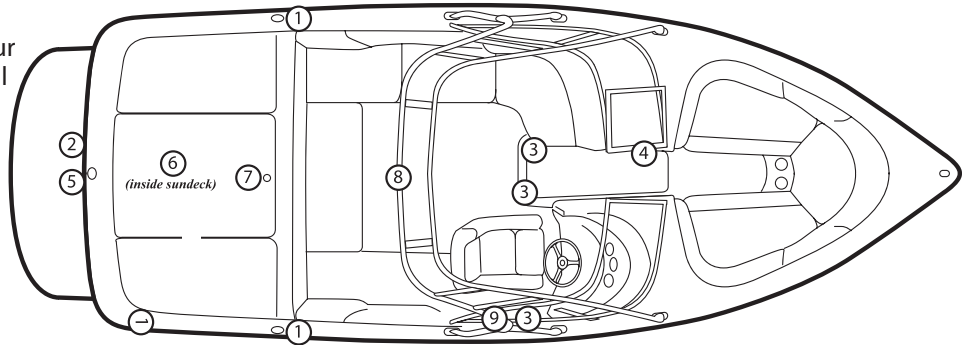

Warning Plates & Labels

Read and note ALL warning plates and labels from bow to stern that appear on the boat, including these.

If your warning decals should become damaged in any way, please contact your Moomba Dealer or write Skier's Choice, Inc. to request replacement warning decals. The decals will be provided free of charge. Your boat's serial number (located on the transom) must be included for warning decal requests.

(one of two places depending on location of fuel cap)

①  **WARNING**

- AVOID SERIOUS INJURY OR DEATH.
- FIRE, EXPLOSION AND SPLASHING FUEL HAZARD.
- IF TANK IS OVERFILLED, FUEL WILL DISCHARGE OUT THIS PORT.

WLFH0804

(only if boat has tow eye)

②  **WARNING**

- AVOID SERIOUS INJURY OR DEATH.
- TOW EYE SHOULD BE USED ONLY FOR TOWABLE WATER SPORTS DEVICES WITH 1 OR 2 INDIVIDUALS. TOW EYE WEIGHT LIMIT IS 300 LBS.
- DO NOT USE TOW EYE FOR OTHER TOWABLE OBJECTS OR TOWING BOATS.
- DO NOT USE TOW EYE TO LIFT BOAT.

WLTE0803

(one of three places)

③  **DANGER**

- CARBON MONOXIDE AND PROPELLER HAZARD. DO NOT OPERATE ENGINE WHILE ANYONE IS ON OR ABOUT THE SWIM PLATFORM OR IN THE WATER NEAR THE BOAT. OWNERS AND OPERATORS MUST READ AND UNDERSTAND ALL PRODUCT WARNINGS AND MANUALS BEFORE USE.

 **WARNING**

- AVOID SERIOUS INJURY FROM LOSS OF BALANCE AND FALLING OVERBOARD. ALL OCCUPANTS MUST REMAIN SEATED AT ALL TIMES WHILE BOAT IS IN MOTION.
- BOAT IS CAPABLE OF QUICK AND TIGHT TURNS. SUCH MANEUVERS CAN CAUSE UNSEATED OCCUPANTS TO BE THROWN AROUND OR OUT OF THE BOAT. ALERT PASSENGERS BEFORE CHANGES IN DIRECTION. THE DRIVER IS RESPONSIBLE FOR OPERATING BOAT IN A MANNER THAT ENSURES THE SAFETY OF PASSENGERS.
- GASOLINE VAPORS CAN EXPLODE. BEFORE STARTING ENGINE, OPEN ENGINE BOX. CHECK ENGINE COMPARTMENT FOR GASOLINE VAPORS, AND OPERATE BLOWER FOR AT LEAST 4 MINUTES. RUN LOWER BELOW CRUISING SPEED.

WLDG0804

④  **WARNING**

- AVOID SERIOUS INJURY OR DEATH FROM LOSS OF BALANCE AND FALLING OVERBOARD.
- CHILDREN SHOULD BE SUPERVISED BY AN ADULT AT ALL TIMES.
- REMAIN PROPERLY SEATED AT ALL TIMES WHILE BOAT IS IN MOTION.
- DO NOT STAND UP OR MOVE ABOUT WHILE THE BOAT IS IN MOTION.

WLOB0804

⑤  **DANGER**

- AVOID SERIOUS INJURY OR DEATH FROM CARBON MONOXIDE AND PROPELLER HAZARD.
- DO NOT BE ON OR ABOUT THE SWIM PLATFORM WHILE ENGINE IS RUNNING OR BOAT IS IN MOTION.
- KEEP AWAY FROM REAR OF BOAT WHILE ENGINE IS RUNNING.

WLSWP0804

(inside motorbox)

⑥  **WARNING**



- AVOID SERIOUS INJURY OR DEATH.
- LEAKING FUEL IS A FIRE AND EXPLOSION HAZARD.
- INSPECT SYSTEM REGULARLY. EXAMINE FUEL SYSTEM FOR LEAKS AND CORROSION AT LEAST ANNUALLY.

WLENG0803

⑦  **WARNING**

- AVOID SERIOUS INJURY OR DEATH.
- TOW PYLON SHOULD BE USED ONLY FOR TOWABLE WATER SPORTS DEVICES.
- DO NOT USE TOW PYLON FOR OTHER TOWABLE OBJECTS OR TOWING BOATS.
- TOW PYLON IS NOT DESIGNED FOR VERTICAL EXTENSIONS. ANY MODIFICATIONS TO THE TOW PYLON OR ITS MOUNTINGS MAY RESULT IN DAMAGE TO THE BOAT AND INJURY TO THE USER.
- DO NOT SIT BEHIND THE TOW PYLON WHEN IN USE.

WLSKP0803

(if equipped with tower)

⑧  **WARNING**

- AVOID SERIOUS INJURY OR DEATH FROM MISUSE OF TOWER.
- THE TOWER IS DESIGNED TO PULL A SINGLE (1) WAKEBOARDER.
- DO NOT CLIMB OR SIT ON THE TOWER.
- DO NOT SIT BEHIND THE PULLING POINT OF THE TOWER TO AVOID CONTACT WITH ROPE.
- THE TOWER MAY STRIKE LOW OBJECTS. CHECK CLEARANCE HEIGHTS DURING OPERATION AND TOWING.

WLTWR0804

⑨  **WARNING**

**LOOSE FITTINGS
MAY RESULT IN
TOWER COLLAPSE.**

**CHECK TIGHTNESS
OF TOWER BOLTS
AND KNOBS BEFORE
EACH USE.**

WLRB0804

Skier's Choice, Inc. reserves the right to change warning labels without notification or incurring obligation. For a copy of the most current warning labels, please contact your dealer or Skier's Choice, Inc.



The time to think about emergencies is before they happen. Plan ahead. Know what to do before you encounter any of these situations. Wear a PFD (Personal Flotation Device) when boating.

Explosion & Fire

⚠️ WARNING

EXPLOSION/FIRE/ASPHYXIATION HAZARD

- Open flame cooking appliances consume oxygen. This can cause asphyxiation or death.
- Maintain open ventilation.
- Liquid fuel may ignite, causing severe burns.
- Use fuel appropriate for type of stove.
- Turn off stove burner before filling.
- Do not use stove for comfort heating.

FIRE/ASPHYXIATION HAZARD - Use special care with flames or high temperatures near urethane foam, if used in construction of your boat. Burning, welding, lights, cigarettes, space heaters and the like can ignite urethane foam. Once ignited, it burns rapidly, producing extreme heat, releasing hazardous gases and consuming much oxygen.

Explosion

- If explosion is imminent, put on PFDs, grab distress signals and survival gear, and immediately abandon ship.

Fire

- Turn off engines, generators, stoves and blowers. Extinguish smoking materials.
- Fixed fire suppression system, if equipped, has heat sensors that automatically flood machinery space with a fire extinguishant. Allow extinguishant to "soak" compartment for at least 15 minutes to cool hot metals or fuel before cautiously inspecting fire area. Have portable fire extinguishers ready. Do not breathe fumes or vapors caused by the fire or extinguishant.
- If no fixed firefighting system is installed and fire is in engine compartment, discharge portable fire extinguishers through engine compartment access plate, if equipped. Do not open engine hatch as this feeds oxygen to the fire.
- If you have access to fire, direct contents of extinguishers at base of flames, not at the top.
- Throw burning materials overboard if possible.
- Move anyone not needed for firefighting operations away from the flames.
- Signal for help.
- Put on PFDs, grab distress signals and survival gear, and prepare to abandon ship.

Abandoning Ship

⚠️ WARNING

BURN HAZARD

Swim against the current or wind if you abandon ship. Leaking fuel will float with the current and may ignite.

- When clear of danger, account for all who were on board, and help those in need.
- Use distress signal.
- Keep everyone together to make rescue easier.

Flooding, Swamping or Capsizing

- **STAY WITH THE BOAT!** A boat will usually float even if there is major hull damage. Rescuers can spot a boat much easier than a head bobbing in the water.
- Signal for help.

Collision

- Account for everyone on board.
- Check for injuries.
- Inspect structural damage.
- Reduce flooding.
- Signal for help.
- **STAY WITH THE BOAT!**

Grounding

Action depends on how hard the boat hits bottom and whether the boat remains stranded. If it is a simple touch, you may need only to inspect the hull. If you are aground, assess the situation before reacting. In some cases, throwing the boat into reverse can cause more damage.

Basic Guidelines

- Inspect damage to hull, propulsion and steering systems.
- Check for leaks. If water is coming in, stopping the flow takes priority over getting free.
- Determine water depth all around the boat and type of bottom (sand, mud, rocks, etc.). This will help you decide which way to move the boat.
- Determine if tide, wind or current will drive the boat harder aground or will help free it.

Leaks

- Immediately switch on bilge pumps.
- Assign crew to operate manual pumps, if needed.
- If boat is taking on water, have someone take the helm while you manage damage control.
- Slow or stop to minimize inflow. However, if you can keep a hole above water by maintaining speed, do so.
- If possible, patch the outside with whatever material is available.

Towing

⚠ WARNING

PERSONAL INJURY HAZARD

Towing or being towed stresses the boats, hardware and lines. Failure of any part can seriously injure people or damage the boat.

A recreational boat towing another is usually a last resort because of possible damage to one or both boats. The Coast Guard or a private salvage company is better equipped. A recreational boat may assist by standing by, and possibly keeping the disabled boat's bow at a proper angle until help arrives. Only when conditions are ideal—that is, waters are calm, disabled boat is small, and one or both skippers know correct technique—should a recreational boat tow another.

Towing Vessel

- Be sure your boat will not run aground too.
- Because you are maneuverable and the grounded boat is not, you should pass the towline to the grounded boat.
- Use double-braided or braid-on-braid line. Never use three-strand twisted nylon; it has too much elasticity and can snap back dangerously.
- Fasten the towline as far forward as possible on the upwind or up-current side of the towing boat.
- Fastening it to the stern will restrict maneuverability of the towing boat.
- If possible, use a bridle.
- Move slowly to prevent sudden strain on slack line.
- Be ready to cast loose or cut the line if the towing situation becomes hazardous.

Vessel Being Towed

- Attach the towline to the bow eye.
- If the boat has eyebolts in the transom for pulling skiers, a towline may be attached to a small bridle hooked to both eyebolts.
- If it is necessary to be towed after being freed, keep someone at the wheel to steer.

Both Vessels

- If you attach the towline to a fitting, be sure the fitting is fastened with a through bolt and is reinforced on the underside.
- Creating a bridle with a line around the hull or superstructure will distribute the load over a wide area; pad pressure points. This technique can be used on both the towing and towed boat.
- Keep lines clear of propellers on both boats.
- Keep hands and feet clear of the other boat.
- Never hold a towline after it is pulled taut.

Person Overboard

- Immediately sound an alarm and keep pointing to the person overboard.
- Throw a life preserver even if the person is wearing a PFD. It will serve as a marker.
- Immediately stop or slow the boat, then circle toward the victim.
- Keep person overboard on helm side so operator has the person constantly in sight.
- Approach from downwind and move alongside into the wind for pickup.
- When almost alongside, stop the engine in gear to prevent dangerous propeller "windmilling."
- As part of your emergency plan, consider what to do if you were alone and fell overboard (e.g., wear PFD, keep signal device in PFD, attach emergency stop switch lanyard to yourself).

Drowning

- Swim to rescue a drowning victim only as a last resort.
- Immediate resuscitation is critical! At least two people on board should be certified in CPR.
- Keep the victim warm.
- Use care in handling. Spinal injury may exist if the victim fell overboard.
- Signal for help.

Medical Emergency

- In an emergency, you may be far from professional medical assistance. Be prepared. Take a first aid course, and carry a first aid kit. Be aware of special conditions that may affect anyone on board.



Carbon Monoxide

Carbon monoxide is an odorless, colorless, extremely toxic gas. Symptoms of carbon monoxide poisoning are dizziness, ears ringing, headaches, nausea and unconsciousness. A poisoning victim's skin often turns cherry red.

Have the victim breathe fresh air deeply. If breathing stops, resuscitate. A victim often revives, then relapses because organs are damaged by lack of oxygen. Seek immediate medical attention.

Propulsion, Control or Steering Failure

- Shut off engine.
- Put out an anchor to prevent drifting.
- Determine if you can fix the problem yourself. See engine operator's manual if engine is flooded.
- Signal for help.

Radio Communication

Radio is the boat operator's main method of receiving safety information and summoning aid. VHF-FM radio is the primary means of short-range communication. Single sideband radio (SSB) is used for longer range communication.

VHF-FM Channel 16 and SSB 2182 kHz are designated for emergency use. Such situations can be categorized as:

- **Emergency** — **"MAYDAY, MAYDAY, MAYDAY"** — Used when a life or vessel is in imminent danger.
- **Urgency** — **"PAN-PAN, PAN-PAN, PAN-PAN"** (pronounced PAHN-PAHN) — Used when a person or vessel is in some jeopardy less than indicated by a Mayday call.
- **Safety** — **"SECURITY, SECURITY, SECURITY"** (pronounced SAY-CURE-IT-TAY) — Used for navigational safety or weather warning.

An emergency situation will be hectic and there will not be time to learn proper radio procedure. **LEARN WHAT TO DO BEFORE YOU NEED TO DO IT.**

If you hear a distress call, stop all radio transmissions. If you can directly assist, respond on the emergency frequency. If you cannot assist, do not transmit on that frequency. However, continue to monitor until it is obvious that help is being provided.

Distress Signals

Consult your national boating law enforcement agency.

Visual Distress Signals

- U.S. Coast Guard regulations require boats in coastal waters and the Great Lakes to carry visual distress signals for day or night use, as appropriate for the time of operation. Exempt from the day signals requirement, but not night signals, are boats less than 4.8 meters (16 feet), open sailboats less than 7.9 meters (26 feet), boats participating in organized events, and manually propelled boats.
- If you are required to have visual distress signals, at least three safety-approved pyrotechnic devices in serviceable condition must be readily accessible. They must be marked with a date showing the service life, which must not be expired.
- Carry three signals for day use and three signals for night use. Some pyrotechnic signals, such as red flares, meet both day and night use requirements.
- Store pyrotechnic signals in a cool, dry location. An orange or red watertight container prominently marked "Distress Signals" is recommended.

Other recognized visual distress signals include:

- Flames in a bucket
- Code flags November and Charlie
- Square flag and ball
- Black square and ball on orange background flag
- Orange flag (certified)
- Electric distress light (certified) - for night use only.
- Dye marker (any color)
- Person waving arms
- U.S. ensign flown upside down

Audible Distress Signals

U.S. Coast Guard regulations require one hand, mouth or power-operated whistle or horn, audible for at least a half mile.

Other recognized audible distress signals include:

- Radio communication (*see Emergency Procedures - Radio Procedures - Radio Communication*)
- Radio-telegraph alarm
- Position indicating radio beacon
- Morse Code SOS (3 short, 3 long, 3 short) sounded by any means
- Fog horn sounded continuously



Basic Boating Rules

You should be aware of these rules and follow them whenever you encounter another vessel on the water.

The rules presented in this manual are condensed and have been provided as a convenience only. Consult your local U.S. Coast Guard Auxiliary (USCGA) or Department of Motor Vehicles (DMV) for a complete set of rules governing the waters in which you will be using your boat. If you plan to travel—even for a short trip—you would be well served to contact the regional USCGA or DMV in the area where you will be boating.

Review and understand all local and state laws.

Any time two vessels on the water meet one another, one vessel has the right-of-way. It is called the stand-on vessel. The vessel which does NOT have the right-of-way is called the give-way or burdened vessel.

These rules determine which vessel has the right-of-way, and accordingly, what each vessel should do.

The vessel with the right-of-way has the duty to continue its course and speed, except to avoid an immediate collision. When you maintain your direction and speed, the other vessel will be able to determine how best to avoid you.

The vessel which does not have the right-of-way has the duty to take positive and timely action to stay out of the way of the stand-on vessel. Normally, the give-way vessel should not cross in front of the stand-on vessel. Slow down or change directions briefly and pass behind the other vessel. You should always move in such a way that the stand-on operator can see what you are doing.

This rule is called Rule 2 in the International Rules and says, "In obeying and construing these rules due regard shall be had to all dangers of navigation and collision, and to any special circumstances, which may render a departure from the above rules necessary in order to avoid immediate danger."

Encountering Other Vessels

There are three main situations in which you may encounter other vessels and you must observe the Steering Rules in order to avoid a collision. These are:

- Meeting (you are approaching another vessel head-on)
- Crossing (you are traveling across the other vessel's path)
- Overtaking (you are passing or being passed by another vessel)

Using the following illustration in which you are the boat in the center, you should give right-of-way to all vessels shown in the white area. In this instance, you are the give-way vessel. All vessels in the shaded area must yield to you as you are the stand-on vessel. Both you and the meeting vessel must alter course to avoid each other.

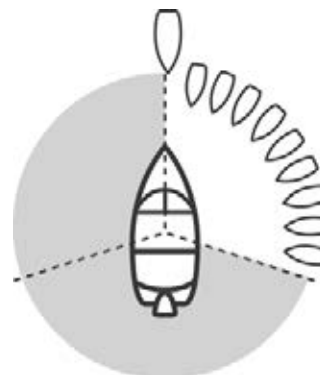

If you are meeting another power vessel head-on, and you are close enough to run the risk of collision, neither of you has the right-of-way. Both of you should alter course to avoid an accident. You should keep the other vessel on your port (left) side. This rule doesn't apply if both of you can clear each other by continuing your set course and speed.

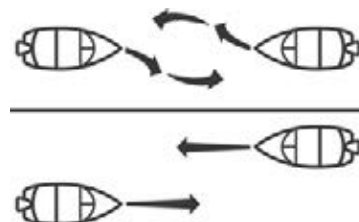

When two power-driven vessels are crossing each other's path close enough to run the risk of collision, the vessel that views the crossing vessel to the starboard (right) side must give-way.

If the other vessel is to the port (left) side, maintain your course and direction, provided the other vessel gives you the right-of-way as it should.

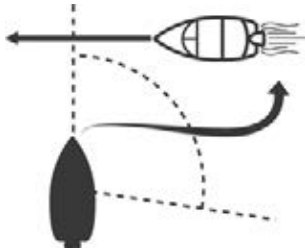

If you are passing another vessel, you are the give-way vessel. This means that the other vessel is expected to maintain its course and speed. You must stay out of its way as you clear it, altering course and speed as necessary.

Conversely, if you are being passed by another vessel, you should maintain your speed and direction so that the other vessel can steer itself around you.

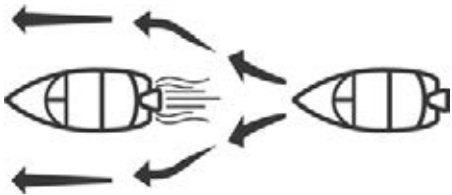

There are three other rules to always remember when driving your boat around other vessels.

When navigating in narrow channels, you should keep to the right when it is safe and practical to do so. If the operator of a power-driven vessel is preparing to go around a bend that may obstruct the view of other water vessels, the operator should sound a prolonged blast on the whistle or horn—four to six seconds.

If another vessel is around the bend, it too should sound the whistle or horn. Even if no reply is heard, however, the vessel should still proceed around the bend with caution.

If you navigate these type of waters, you should carry a portable air horn, which are available from local marine supply stores.

All vessels which are fishing with nets, lines or trawls are considered under International Rules to be fishing vessels. Boats with trolling lines are not considered fishing vessels.

Fishing vessels have the right-of-way, regardless of position. These vessels, however, cannot impede the passage of other vessels in narrow channels.

Sailing vessels should normally be given the right-of-way. The exceptions to this are:

- When the sailing vessel is overtaking the power-driven vessel, the power-driven vessel has the right-of-way.
- Sailing vessels should keep clear of any fishing vessel.
- In a narrow channel, a sailing vessel should not hamper the safe passage of a power-driven vessel which can navigate only in such a channel.

The waters of the United States are marked for safe navigation by the lateral system of buoyage. The markers and buoys you will encounter have an arrangement of shapes, colors, numbers and lights to show which side of the buoy a boater should pass when navigating in a particular direction.

The markings on these buoys are oriented from the perspective of being entered from seaward while the boater is going towards the port. This means that red buoys are passed on the starboard (right) side when proceeding from open water into port, and black buoys are to port (left) side. When navigating out of port, your position to the buoys should be reversed: red buoys to port and black buoys to starboard.

Many boating bodies of water are entirely within the boundaries of a single state. The Uniform State Waterway Marking Systems has been devised for these waters. This system uses buoys and signs with distinctive shapes and colors to show regulatory or advisory information.

These markers are white with black letters and orange borders. The information signifies speed zones, restricted areas, danger areas and general information.

Remember: Markings may vary by geographic location. Always consult local boating authorities before driving your boat in unfamiliar waters.

(See examples of buoys and markers next page.)



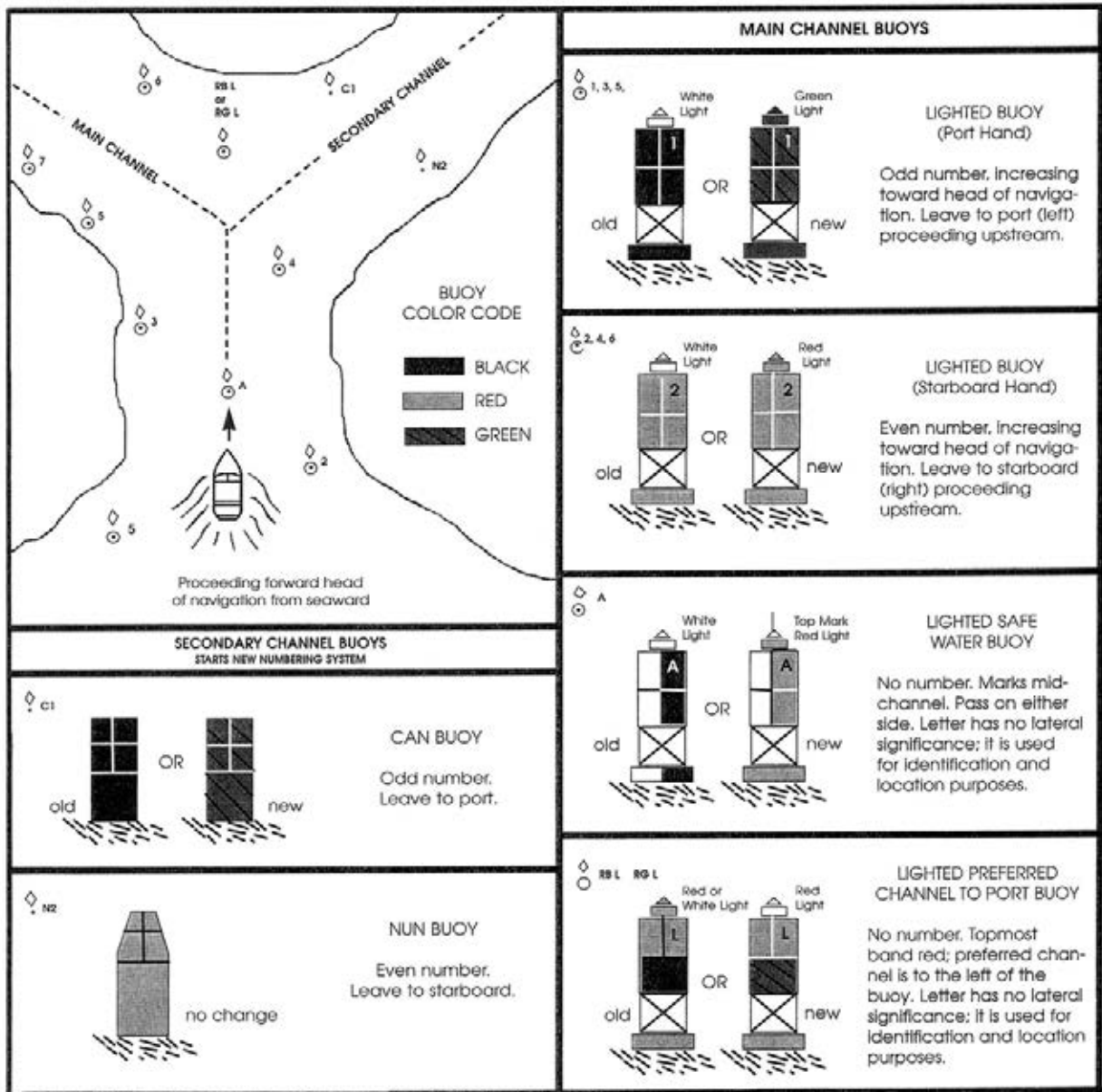

Sunsport 20V

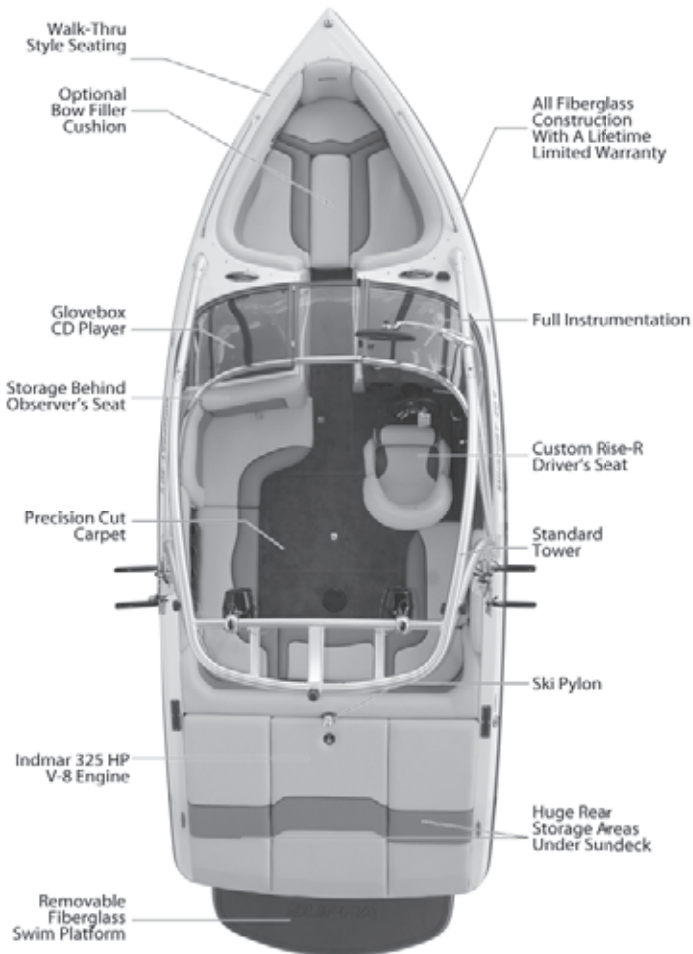

Sunsport 22V

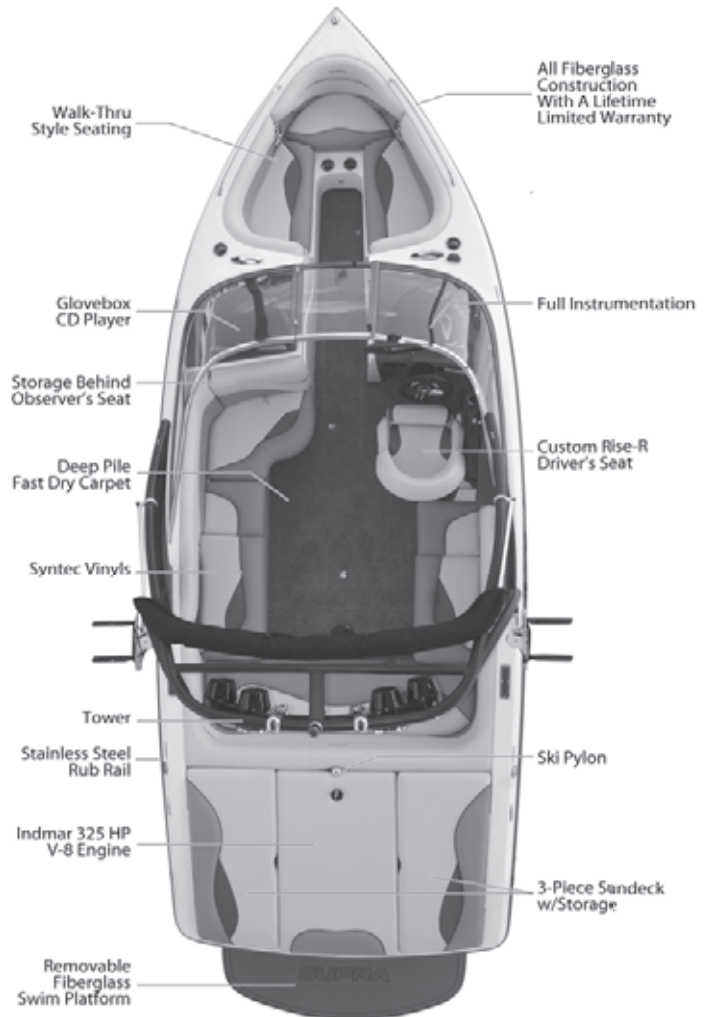

Boat Specifications:

Overall Length w/o Platform	20' 8"
Overall Length w/Platform	22' 10"
Overall Length w/Trailer	24' 8"
Width (Beam)	95"
Draft	24"
Weight - Boat Only	3,200 lbs.
Weight - Boat & Trailer	4,050 lbs.
Capacity - Passenger	10
Capacity - Weight	1,480 lbs.
Capacity - Fuel	39 gals.
Engine	330 HP, MPI V-8

Boat Specifications:

Overall Length w/o Platform	22' 6"
Overall Length w/Platform	24' 6"
Overall Length w/Trailer	26' 4"
Width (Beam)	100"
Draft	25"
Weight - Boat Only	3,800 lbs.
Weight - Boat & Trailer	4,900 lbs.
Capacity - Passenger	15
Capacity - Weight	2,100 lbs.
Capacity - Fuel	50 gals.
Engine	330 HP, MPI V-8



Launch 21V

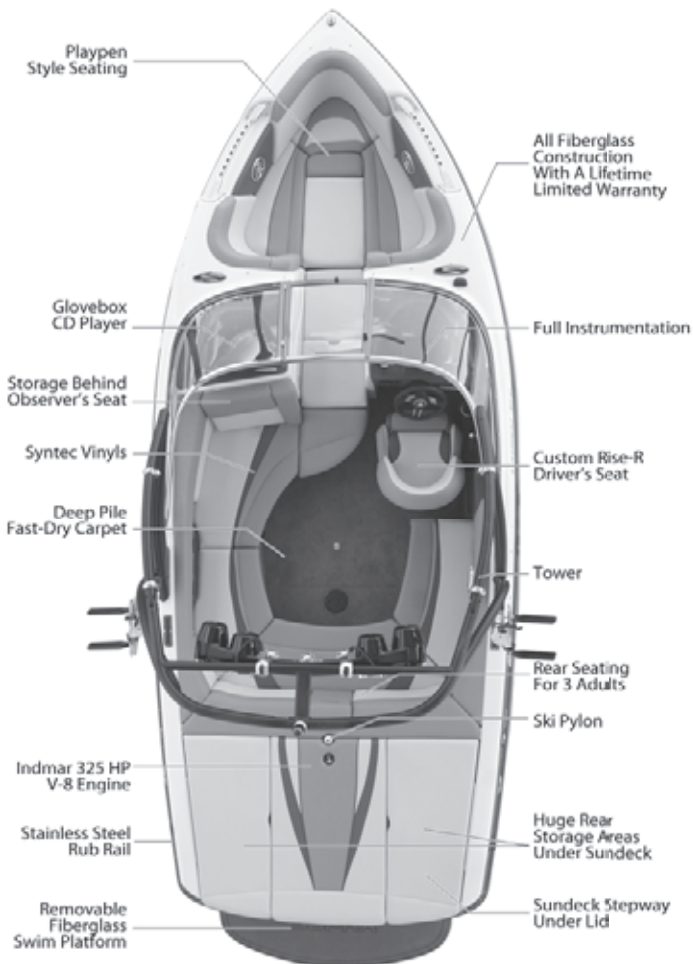

Boat Specifications:

Overall Length w/o Platform	21' 4"
Overall Length w/Platform	23'
Overall Length w/Trailer	25' 3"
Width (Beam)	99"
Draft	25"
Weight - Boat Only	3,800 lbs.
Weight - Boat & Trailer	4,900 lbs.
Capacity - Passenger	14
Capacity - Weight	1,950 lbs.
Capacity - Fuel	50 gals.
Engine	330 HP, MPI V-8

Launch 22V

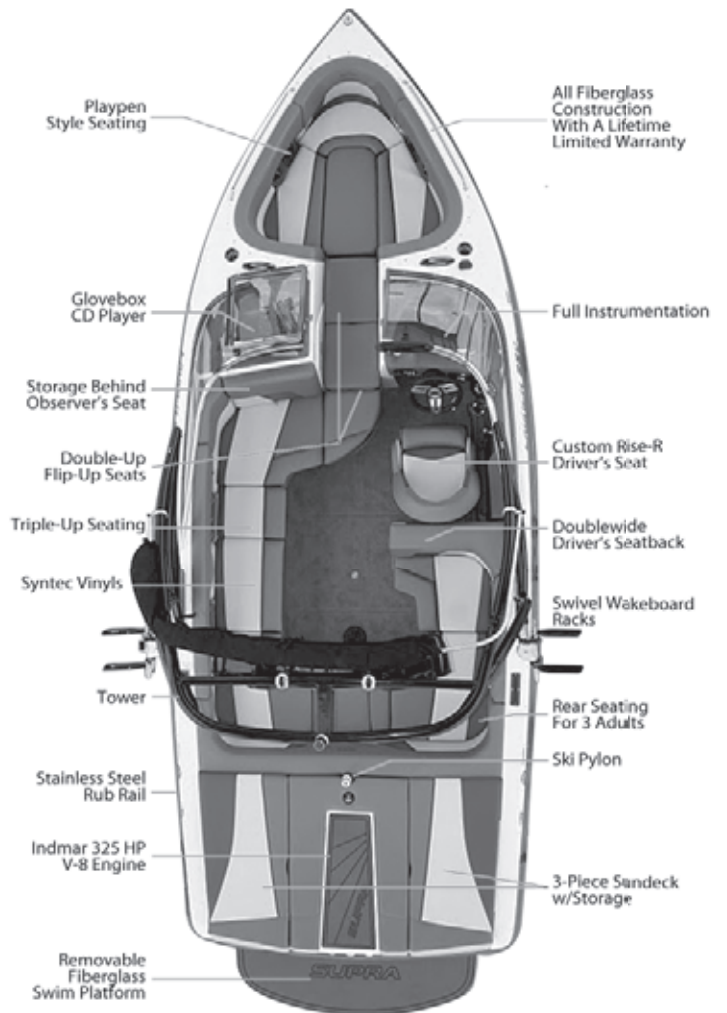

Boat Specifications:

Overall Length w/o Platform	22' 6"
Overall Length w/Platform	24' 6"
Overall Length w/Trailer	26' 4"
Width (Beam)	100"
Draft	25"
Weight - Boat Only	3,800 lbs.
Weight - Boat & Trailer	4,900 lbs.
Capacity - Passenger	15
Capacity - Weight	2,100 lbs.
Capacity - Fuel	50 gals.
Engine	330 HP, MPI V-8



Launch 242

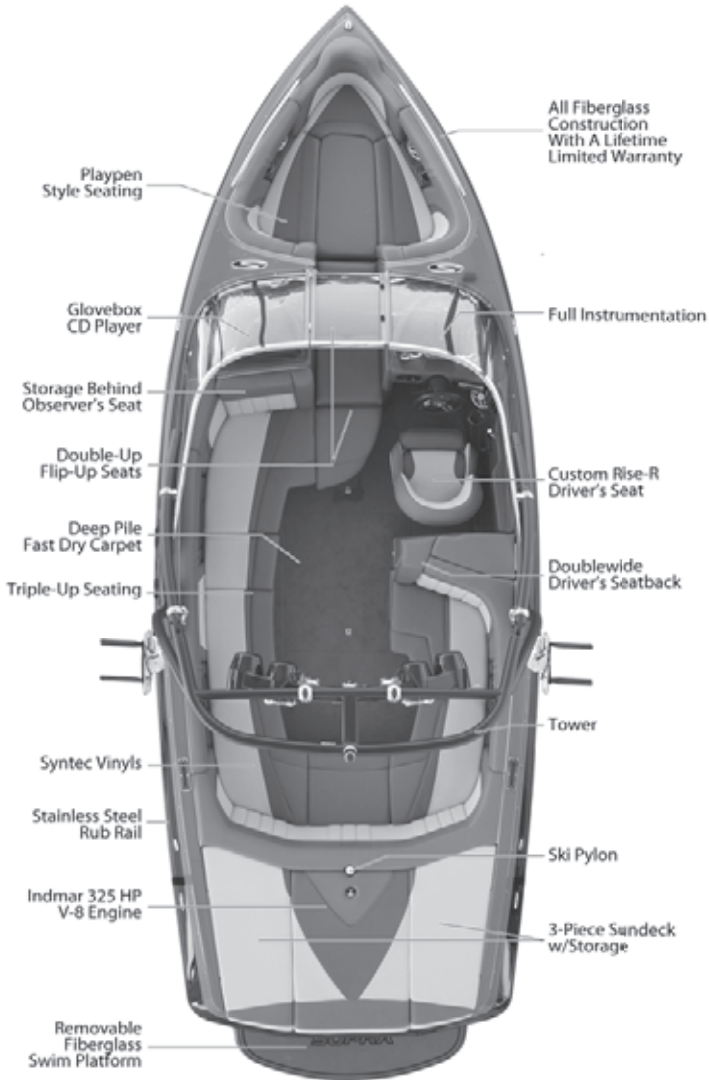

Boat Specifications:

Overall Length w/o Platform	24' 2"
Overall Length w/Platform	26' 1"
Overall Length w/Trailer	27' 11"
Width (Beam)	102"
Draft	26"
Weight - Boat Only	4,450 lbs.
Weight - Boat & Trailer	5,700 lbs.
Capacity - Passenger	17
Capacity - Weight	2,400 lbs.
Capacity - Fuel	68 gals.
Engine	345 HP, MPI V-8



Break In Period

Taking care to properly break in your new engine will pay off in the long run. In our years of field testing, we have proven that an Indmar engine, when properly broken in according to our simple procedures, will last longer, run better and have fewer repairs over its lifetime.

Your new engine does not require an elaborate break-in procedure. Just follow these simple instructions and you are off to a great start.

The three (3) most important aspects of new engine break-in are:

1. Avoid running engine at high speeds.
2. Do not carry a heavy load (passengers, gear, etc.).
3. Vary your boat speed during break-in. Don't run at the same RPM for a long period of time.

BREAK-IN STEPS

- For the first hour, do not exceed 2,000 RPM.
- For the second hour, do not exceed 3,000 RPM.
- For the next five hours, do not exceed 4,000 RPM

BREAK-IN TIPS

- Avoid fast accelerations and don't carry (or pull) a heavy load during this period.
- Always let engine warm up gradually before acceleration.
- Check oil frequently. During the first 50 to 100 hours, an engine can use more oil than usual. Maintain oil at a proper level at all times (do not overfill).
- Monitor transmission fluid levels.
- Report abnormal noises or vibrations to your dealer.
- Keep an eye out for loose mountings, fittings, nuts, bolts, and clamps.

During the BREAK-IN process, engine temperature should be carefully monitored and speed should be reduced if overheating is evident. **ALSO, PLEASE REFER TO ENGINE OWNER'S MANUAL FOR BREAK-IN INFORMATION.**

NOTICE: PLEASE REFER TO ENGINE OWNER'S MANUAL for maximum RPM and engine break-in procedure.

After the first 20 hours of operation, take your boat to the dealer for its first oil and filter change, as well as an engine checkup. Remember to keep a sharp eye on all gauges and warning lights during these first hours of operation. Report anything unusual to your dealer.

After the break-in procedure is over, your boat may be operated continuously at any speed.

CAUTION

Do not exceed maximum RPM recommended for your engine. Exceeding the maximum RPM may result in damage to the engine.

CAUTION

Before starting your engine you must open the engine box and check engine compartment and bilge for gasoline and oil vapors.



Starting & Operation

A standard pre-starting procedure should be always be followed before the first start-up of the day.

1. Check the engine oil level.
2. Check for gasoline fumes in bilge or engine compartment.
3. Operate engine blower for 4 minutes before starting the engine to remove any fumes.
4. Check manual operation of bilge pump. Make sure bilge areas are empty.

Other items might also be inspected, depending on the boat and its use. It is advisable to formulate a check list particular to the equipment and operation of your boat.

REFER TO THE BOATMAN'S CHECKLIST OF THIS MANUAL.

Consult the local Coast Guard Auxiliary or Power Squadron for full details on boating safety.

NOTE: Add-on electrical accessories should never be connected to the ignition terminal or ignition circuit.

IMPORTANT: DO NOT continue to operate the starter for more than 15 seconds at a time without pausing to allow the starter motor to cool down for at least 2 minutes. This will also allow the battery to recover between starting attempts. PLEASE REFER TO ENGINE OWNER'S MANUAL FOR ADDITIONAL DETAILS.

BEFORE STARTING ENGINE, BE SURE THAT THE SHIFT SELECTOR IS IN NEUTRAL.

The correct starting procedure depends upon the type of engine. Please refer to the engine manual before starting.

Coast Guard Regulations

The United States Coast Guard boating regulations prescribe minimum standards of safety to be met and maintained by all watercraft. It is necessary that your boat remain in compliance with these regulations.

The staff at Skier's Choice, Inc. recommend that all boat operators complete a Coast Guard approved boating safety course.



Maximum Capacities

In compliance with United States Coast Guard Regulations, Supra Boats meet or exceed all safety standards designed for recreational boats. To ensure safe handling and performance, each Supra boat displays a maximum capacity sticker (see sample), stating the maximum total weight load allowable.

NOTICE: Refer to the Maximum Capacity Sticker on your boat for allowable loading.

WARNING

Do not exceed the maximum capacity of the boat.



A standard pre-starting procedure should always be followed before the first start-up of the day.

1. Check the engine oil level.
2. Check for gasoline fumes in bilge or engine compartment.
3. Operate engine blower for 4 minutes before starting the engine to remove any fumes.
4. Check manual operation of bilge pump. Make sure bilge areas are empty.

Other items might also be inspected, depending on the boat and its use. It is advisable to formulate a check list particular to the equipment and operation of your boat.

REFER TO THE BOATMAN'S CHECKLIST OF THIS MANUAL.

Consult the local Coast Guard Auxiliary or Power Squadron for full details on boating safety.

NOTE: Add-on electrical accessories should never be connected to the ignition terminal or ignition circuit.

IMPORTANT: DO NOT continue to operate the starter for more than 15 seconds at a time without pausing to allow the starter motor to cool down for at least 2 minutes. This will also allow the battery to recover between starting attempts. PLEASE REFER TO ENGINE OWNER'S MANUAL FOR ADDITIONAL DETAILS.

⚠ DANGER

BEFORE STARTING ENGINE, BE SURE THAT THE SHIFT SELECTOR IS IN NEUTRAL.

The correct starting procedure depends upon the type of engine. Please refer to the engine manual before starting.

⚠ DANGER

Do not start engine if gas fumes are present.

To Start Electronic Fuel Injection (EFI) Engine

1. Place shift selector in Neutral with the throttle in the upright (zero) position. (If throttle is not in the idle position, the throttle position sensor will not allow the engine computer to proceed with a normal starting procedure).
2. Turn Ignition Key to Start Position to operate the starter.
3. Release the Key when engine starts (key will return to run position).
4. Allow the engine to establish a good idle (30 to 60 seconds) before getting underway.
5. Shift slowly into forward or reverse, allowing the transmission time to engage before powering up.

NOTE: It is normal for the idle to speed up in cold start conditions.

⚠ CAUTION

DO NOT continue to operate the starter for more than 15 seconds at a time without pausing to allow the starter motor to cool down for at least 2 minutes. This will also allow the battery to recover between starting attempts. PLEASE REFER TO ENGINE OWNER'S MANUAL FOR ADDITIONAL DETAILS.

NOTE: Should the EFI engine become "flooded" use the following procedure to start:

1. Place shift selector in Neutral and disengage the transmission by pushing the transmission lockout button located at the bottom of the lever.
2. With the transmission disengaged, push the lever forward to full throttle position. (This will cause the computer to shut off the fuel injectors, which will allow the engine to clear of excess fuel during starting).
3. Turn the Ignition Key to Start Position and operate the starter for no more than 15 seconds at a time, until the engine starts.
4. When the engine starts, back off the throttle and allow the engine to establish a good idle (30 to 60 seconds).
5. Return the throttle to idle position and the transmission lockout will automatically reengage the transmission in neutral position.
6. When ready to get underway, shift slowly into forward or reverse, allowing the transmission time to engage the gearing before powering up.



Engine Warm-Up

Always let engine warm up to normal operating temperature before accelerating.



Supra Team Rider — Josh Sanders

Throttle Lever



The throttle lever controls both the throttle and the transmission. The idle position (normally vertical) is the zero throttle position and the neutral position for the transmission. A safety ring (umbrella) keeps the lever from being accidentally moved to engage the transmission.

To place the transmission into gear, with your hand placed over the lever ball, pull up on the safety ring (umbrella) and slowly push the lever into forward gear or slowly pull the lever back into reverse gear.

CAUTION

Never shift the lever directly from the neutral (vertical) position into a speed position.

- To prevent damage to the transmission, always allow the transmission time to engage before accelerating the engine.
- Once the transmission's engaged, you may accelerate as quickly as you like.



The Transmission Lockout button allows the transmission to be disengaged while giving the throttle full operating range. With the lever in the idle position (normally vertical), push the button located at the bottom of the lever to disengage the transmission. The throttle may then be operated in any open position (forward of neutral or back of neutral upright position). Return the throttle to idle position, and the transmission lockout will automatically reengage the transmission in neutral position.



Center Drain Plug

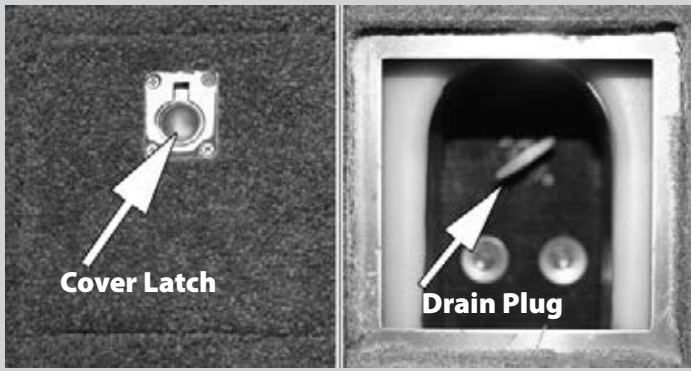

On V-drive models the center drain plug is accessed via the access cover in the center floor panel.

It is extremely important that the drain plug is always checked before starting the engine. The drain plug should be secured in place using a wrench.

⚠ WARNING

DO NOT start engine until center drain plug is checked and secured in place.

Rear Drain Plug



The rear drain plug is located at the back of the boat, near the bottom of the transom (See photo). It is extremely important that the drain plug is always checked before starting the engine. The drain plug should be secured in place using a wrench.

⚠ WARNING

DO NOT start the engine until the drain plug is checked and secured in place.

DO NOT try to install the drain plug while the engine is running.



Fuel Precautions



Use a gasoline with a minimum octane rating of 89. The H.O. engine should use a minimum octane rating of 91. See engine owner's manual for more information.

⚠️ WARNING

DO NOT use gasoline containing methyl alcohol (methanol). Methanol can damage your boat's fuel system.

⚠️ CAUTION

Gasoline Stabilizer should be added to the fuel tank when the boat is used infrequently or whenever your boat will not be used for two weeks or more. During storage, always add Gasoline Stabilizer to reduce gumming or tank sludge.

⚠️ CAUTION

E-10 fuels require fuel stabilizers that are specifically designed for E-10 fuels to help prevent moisture absorption, phase separation and gasoline stabilization.

Filling the Tank



⚠️ CAUTION

Be especially careful when filling the fuel tank. DO NOT over fill the tank. Fuel may empty through the fuel vent and damage to finishes could result.

If fuel is spilled on stripes or decals, apply a common bath cleaner (nonabrasive) and wipe with a damp cloth. Rinse the spill area with clean water.

Fueling



⚠️ WARNING

Sparks while fueling could cause an explosion!

Before Fueling:

1. Turn off engine.
2. Turn off ignition.
3. Extinguish cigarettes or any open flame.

While Fueling:

1. Keep hose nozzle in contact with fill pipe to provide a ground against static sparks.
2. Fill tank at a slow rate to avoid any spillage.

Fuel Cap

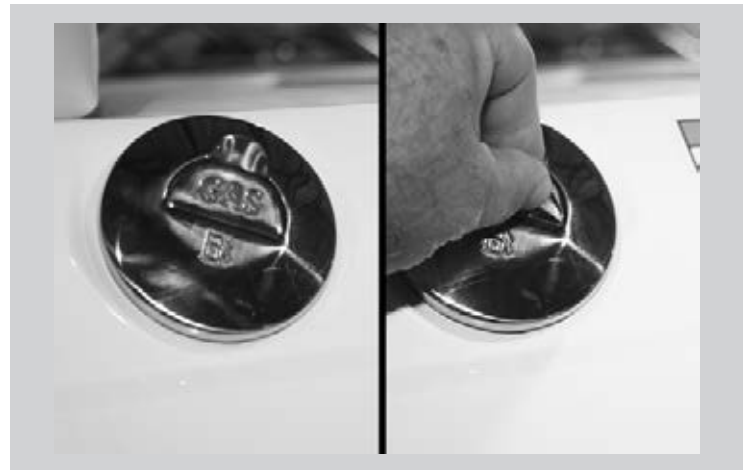

The fuel cap is located on the rear deck near the stern.

NOTE: The cap is sealed by a rubber O-ring. Please do not over tighten.

The 21V, 22V and 242 Series boats, for extra convenience, have a fuel fill on both sides to allow for easy fueling.





This section provides the information needed to understand and operate the VISION Dash System installed on all Supra Boat Models.

The instrument system includes gauges, digital displays, and a Graphical Information Center to communicate vital real-time information about the status and performance of the boat to the driver. By just glancing at the dash, the driver can determine:

- Boat Speed
- Zero Off™
- Smart Plate™
- Depth
- Engine RPM
- Remaining Fuel
- Lake Temperature
- Air Temperature
- Engine Oil Pressure
- Engine Coolant Temperature
- Battery Voltage
- Ballast

Supra Helm Station Layout



Slalom Course Speeds:		
MPH	Seconds	Allowable
+ or - 1/2 MPH		Times / (Secs)
18	32.19	32.0 - 32.6
20	28.97	28.0 - 28.6
30	19.31	19.0 - 19.6
32	18.11	17.9 - 18.3
34	16.95	16.8 - 17.2
36	16.08	15.9 - 16.3

(Times are from start gate to end gate)

Speed may be checked using a stopwatch and a standard slalom course.

Speed may also be checked by using a hand-held GPS.



Tachometer



The tachometer indicates the engine revolutions per minute (RPM).

DO NOT exceed the recommended RPM during break-in and normal operation of your motor. Exceeding the manufacturer's suggested RPM may cause damage to the engine.

Speedometer

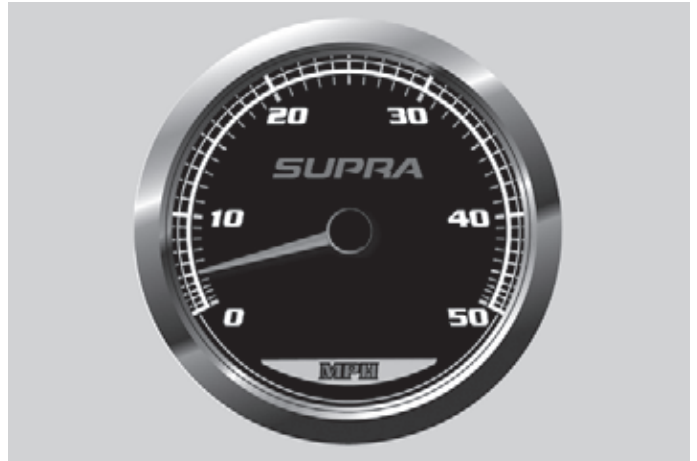

The speedometer indicates the water speed of the boat in miles per hour. It is recommended that the speedometer be checked for accuracy periodically.

Engine Data Displayed on VISION Center Main Page

Oil Pressure Display

The oil pressure display indicates the oil pressure in the engine while the engine is running. If the oil pressure remains below the normal range of 10 to 80 psi, stop the engine immediately. If engine is allowed to run while oil pressure is too low, permanent engine damage may occur.

CAUTION

Running the engine with low oil pressure may cause severe engine damage.

Coolant Temperature Display

The temperature display indicates the engine coolant temperature while the coolant is circulating inside the engine. Engine operating temperatures will vary depending on the weather conditions and engine load. Normal operating temp range is between 160 degrees and 180 degrees.

NOTICE: Refer to your Engine Owner's Manual for additional details.

CAUTION

Damage from overheating an engine IS NOT warrantable.

Voltage Display

The voltage displayed indicates the battery voltage when the engine is running or the battery voltage when the engine is stopped. The voltmeter should indicate a voltage between 13 and 16 volts when the engine is running.



Speedometer Paddle Wheel

The Speedometer pickup is a paddle wheel located on the bottom of the boat. Poor water conditions may cause the wheel to become clogged or give incorrect information.



Fuel Gauge



The Fuel Gauge indicates the amount of fuel remaining in the fuel tank.

This gauge indicates the approximate quantity of fuel remaining in the tank when the ignition is in the "ON" position.

NOTICE: DO NOT run the tank to empty. To prevent condensation from forming in the tank, it is recommended that the tank be filled when the gauge indicates 1/4 tank of fuel remaining.

The following conditions may be considered normal operation of the fuel gauge and fuel system:

- Gas station pumps may shut off before the fuel gauge indicates FULL.
- The amount of fuel required for fill-up may not exactly correspond to the gauge.
- The gauge needle may not move away from FULL until some time after fill-up.
- The gauge needle may move around when boat is in motion.

NOTICE: Become familiar with engine hourly fuel consumption at various speeds and know when to check the fuel gauge.

Trim Gauge



The Trim Gauge indicates the position of the Wake Plate.



Supra VISION



The Supra display is designed for instrumentation and control on electronically controlled engines communicating via SAE J1939 and NMEA 2000. The display is a multi-functional tool that provides GPS tracking, Multimedia Display, Cruise control, and enables equipment operators to view many different engine, ballast, transmission parameters and service codes.



Care and Maintenance

General maintenance is not required; however a soft cloth can be used for cleaning the unit. Window cleaner or alcohol can also be used to clean the glass portion of the display. Do not use harsh or abrasive cleaners on the unit.

Basic Navigation Features

All product features are easily accessed through Quick Access Keys, Menus, and Soft Key commands.



Quick Access Keys

The keys located to the left of the display, provide one-button access to Home Display, GPS Display, Multimedia Display and User Presets Screens.

MENU Key

The Menu provides a list of available features, utilities, and diagnostics.

Soft Key Commands

Soft key commands provide additional features and navigation shortcuts. Depending on the current screen being displayed, they may appear as icons or a vertical control bar. When available, additional soft key commands are accessed by pressing .

Soft Keys

The soft keys correspond to the Soft Key Commands and activate features accordingly when pressed.

ENTER Key

The Enter key advances to the next page of soft key commands. The Enter key may also be used to confirm a SAVE when prompted.

Quick Access Key Features

This section describes the features accessed through the Quick Access Keys located to the left of the display.

Home Display

The Home Display screen for viewing engine statistics can be accessed by pressing the Quick Access Key .



Pressing the ENTER key launches the Soft Key Commands to overlay the right side of the display.

ENTER Key



Home Display - Soft Key Commands

ZERO ON/OFF – indicates the current state of cruise and toggles the cruise control On or Off.



ZERO OFF – selecting ZERO OFF from the Home Display screen engages the cruise control in the 'ON THE GO' mode.

While in 'ON THE GO' mode, the following soft keys are available:

- UP – DOWN** – increase or decrease the target speed.
- SAVE** – creates a new user profile from the current cruise settings. Use **PREV**, **NEXT**, and **SELECT** to enter a new users name, then press **SAVE**.



NOTE: For more information on Profiles, refer to the User Presets Screen section.

VIDEO ON / OFF – displays full-screen input from video in. Pressing the key a second time overlays a reduced video window onto the Home Display screen, allowing user, cruise, and gauge information to be viewed simultaneously. A third key press turns Off the video feature.



NOTE: Full screen video is not available when cruise is engaged. In addition to the gauge screen, the partial video can also be seen in the Multimedia Display screen.

CRUISE SETUP – accesses user profiles and cruise controls



The Cruise feature is explained in more detail in the "User Presets Screen" section.

SMART PLATE – feature currently inactive.

GPS Display

The GPS Display screen can be accessed by pressing the GPS key. The GPS feature displays map data, Latitude and Longitude coordinates, time, and speed. Additional Soft Key Commands are accessed by pressing ENTER Key .



GPS Display - Soft Key Commands



CRUISE ON/OFF – initiates cruise control in ‘on the go’ mode or turns cruise off. While Cruise is engaged, the following soft keys are available:
INC – increases speed while in cruise mode.
DEC – decreases speed while in cruise mode.
CRUISE ON/OFF – turns cruise mode off.



ZOOM IN – ZOOM OUT – this feature lets you zoom in for more detail or zoom out for a larger view of the area map.

TRACK INFO – Tracking shows the current route and any waypoints you have set. A green arrow indicates your current position, while the red square indicates the initial point of tracking.



Soft Key Commands for Track Info include:

SAVE TRACK – displays the following confirmation message before saving the current track information.

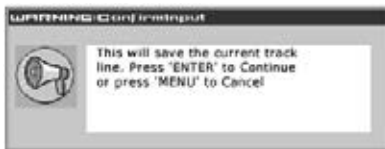

DELETETRACK – displays the following confirmation message before deleting the current track information.

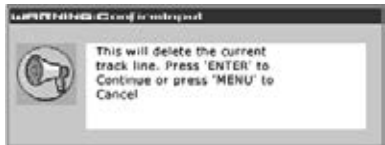

WPT – places a marker or ‘waypoint’ on the map to mark a favorite location after displaying the following confirmation message..

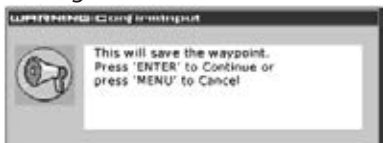

CURRENT POSITION – used to return to the current boat/satellite position after having moved the cursor to another location.

GPS LAT/LON – displays latitude, longitude, course and speed.



NORTH UP – determines how the orientation of the map is displayed; either conventional ‘North Up’, or according to the current course heading, ‘Course Up’.

DAY/NIGHT - toggles the display to the opposite mode for ambient lighting.



EXIT TRACK INFO – removes Track Info soft keys and displays GPS soft keys.

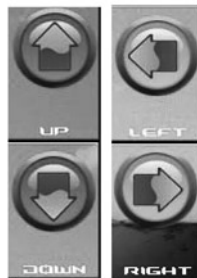

UP – LEFT – RIGHT - DOWN – facilitates navigation of the GPS map by moving the cross-hairs accordingly.

NOTE: –Additional Map cards are available at authorized Supra dealers.



Multimedia Display

Multimedia Display can be accessed by pressing the Quick Access Key .

This feature provides universal control to the Clarion stereo mimicking all the controls of a standard remote control. This includes iPod and Thumb Drive music.



Pressing **ENTER** launches the Soft Key Commands to overlay the right side of the display.

When Cruise is 'ON', the first level of soft keys displayed will control the speed for Zero Off.



UP – DOWN – increase or decrease the target speed.

SAVE – creates a new user profile from the current cruise settings.

Multimedia Display - Soft Key Commands



VOLUME UP – VOLUME DOWN – controls the volume.



PREV TRACK – NEXT TRACK – plays the previous or next track of the current CD playing.



PLAY/PAUSE – toggles between Play and Pause modes when a CD is playing.



UNDEFINED – feature currently unavailable.



MODE – choose between IPOD, USB, and Stereo.



UNDEFINED – feature currently unavailable.



SOURCE POWER – toggle power On and Off.



VIDEO – video displays in window



EQ – feature currently unavailable.



DISPLAY – feature currently unavailable.



User Presets Screen

The User Presets screen can be accessed by pressing the Quick Access Key .

This feature displays rider/skier profiles for cruise controls based on user preferences for speed, ballast, and smart plate settings.

The unit comes preloaded with three default user profiles (ski, wakeboard, and surf) with the ability to define 9 additional users. You may also load another 10 predefined users via USB connection. For more detailed information on setting up users, refer to the 'User Presets Screen – Soft Key Commands'.



User Presets Screen - Soft Key Commands

EDIT PROFILE – provides utilities for adding new users, editing existing users, and copying/loading user profiles through USB connection.



Soft Key Commands for Edit Profile include:

PREV – NEXT – navigates from field to field.

UP – DOWN – when positioned in the 'Name' field, UP/DOWN moves from user to user. When positioned in other columns, UP/DOWN increases or decreases the value.

NEW USER – provides an interface to add new user information. Use **PREV / NEXT** arrows to navigate alpha/numeric keys. Press **SELECT** when a desired character is highlighted.

Press **SAVE** when user information is complete.



EDIT USER – select and edit existing user name information.
DELETE USER – deletes selected user name after confirmation warning.



SAVE/EXIT – saves any new or changed user information and exits to the User Presets Screen.

PICK USER – use to select the desired user profile. Once selected, Cruise is activated and the following screen is displayed showing the user's profile at the top of the screen:



While this screen is being displayed, the following soft key icons are available:

UP / DOWN – increase or decrease cruise speed.

SAVE – saves the current cruise settings to the currently selected users profile.

You can also create a new user profile from the current cruise settings by using **PREV, NEXT,** and **SELECT** to enter a new users name, then press **SAVE**.

SCROLL – displays the next screen(s) of predefined and default users.



LOAD USB – this feature allows you to load predefined users (External Memory) from USB or to save user information (Internal Memory) to USB for loading onto another unit.



Soft Key Commands for Load USB include:

COPY ALL – copies every entry in the currently selected list to the opposite list.

DELETE – deletes the currently selected user entry from the list after displaying the confirmation warning.



DELETE ALL – deletes all entries from the currently selected list after displaying the confirmation warning.



SWAP ALL – depending on which list is selected, copies all entries from internal memory to external memory or all entries from external memory to internal memory.

TOGGLE – toggles between External and Internal Memory list of users.

UP – DOWN – navigates through list of users

COPY – copies the currently selected user to the opposite list (internal vs. external memory).

MENU Options



The MENU is displayed by pressing the MENU key. The following features are available:

- **User Settings** – allows you to customize the display options for ambient light and brightness, set US or metric units, specify the Home screen and screen setup status.
- **Engine Diagnostics** – displays a list of engine fault codes and descriptions; on some engines, corrective action will be shown.
- **Utilities** – allows configuration of the unit including wire configuration, plug address, fault conversion, CAN data, and fault codes. Also displays software version information at the top of the page.
- **GPS Utilities** – contains options to set up track and position, chart and time, and waypoint manager. Also displays satellite status.

User Settings

User Settings provide options to specify viewing preferences. Pressing **PREV** and **NEXT** navigates through the options, and **UP** and **DOWN** scrolls through the selections for each option.



Soft Key Commands for User Settings include:

UP – DOWN – changes the value of the current field.

PREV – NEXT – moves from field to field.

RESTORE DEFAULTS - Loads the factory defaults after displaying a confirmation warning.



SAVE/EXIT – saves the current values and exits.

Ambient Light

Night and Day options are provided for ambient lighting. The screens below illustrate these options. When the ambient lighting settings are changed in User Settings, the power-on default is changed.

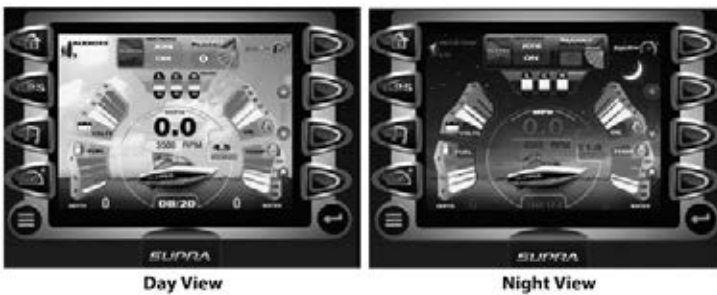

NOTE: The ambient lighting option is also accessible through the Soft Key Commands on the GPS/Track Info screens. Selecting **DAY/NIGHT** toggles the display to the opposite mode.

NavLight

Setting the NavLight to 'Enable' allows the unit to automatically display in Night View when the Nav Lights are enabled. You can still toggle between Day and Night View through the soft key commands.

Brightness

You can set the brightness control by using the UP and DOWN soft keys to change the settings in 5% increments until the desired brightness is achieved.

Video

Specify how video will be displayed from the following choices:

- Disable Video
- Enable Half Screen Mode
- Enable Full Screen Mode
- Enable Full and Half Screen Mode

Minimum Depth

This allows you to choose a minimum depth (measured from bottom of keel) to give an alarm if the vessel comes into a minimum depth situation. Choosing zero turns this option off.

Audio Settings

The Audio Settings feature allows you to set values to automatically increase or decrease the audio volume according to what speed you are traveling.

Volume Up

This allows you to set how much the stereo volume will increase when the crossover speed is reached when accelerating.

Volume Down

This allows you to set how much the stereo volume will decrease when the crossover speed is reached when decelerating.

The Crossover point is determined on the Utilities/Default Settings menu.

Engine Diagnostics

When choosing this selection, the display will query the engine(s) ECU, as illustrated below, and provide feedback on any diagnostic codes that have been activated and stored in the ECU for service needs.



The Engine Diagnostics option displays faults based on engine or transmission source. A description of the fault as well as the suggested action for correction is provided for each fault occurrence.



Soft Key Commands for Engine Diagnostics include:

- GET FAULTS** - query the engine(s) ECU for feedback on diagnostic codes that have been activated and stored in the ECU for service needs.
- UP – DOWN** – navigates through the fault list.
- SAVE** – saves current fault display information.

The following is a list of field definitions contained on the ENGINE DIAGNOSTICS screen:

- Source** – identifies the component having the fault; engine 1, 2, or auxiliary.
- Status** – indicates whether the fault has been corrected.
- SPN** – “Suspect Parameter Number” - fault code. If not translated into text by the display, see the engine manufacturer’s literature for the definition of the SPN number.
- FMI** – “Failure Mode Indicator” - fault code. The FMI is defined by SAE J1939. If not translated into text, see the SAE standard, or the engine manufacturer’s literature.
- Count** – The number of times the event has been flagged.
- Engine Hours** – indicates cumulative number of hours of engine use.
- Description** – Most common SPN’s and FMI’s have text for the description stored in the display. If there is no text, then this SPN and FMI must be defined by referring to the engine manufacturer, or the SAE J1939 standard.

NOTE: This field is only used with certain brands and models of engines.

- Correction** - suggested action for correction.

Fault Code Pop-ups

A fault condition will trigger a pop-up dialog box on the screen describing the nature of the fault. The following screens are examples of warning and shutdown fault codes



How to Hide/Show Faults

To hide the fault code pop-up being displayed on the screen, press the soft key next to the “Hide” icon. The pop-up will disappear, however the “Warning” or “Stop” icon will remain on the screen to indicate there is still a fault. Pressing “Hide” does not clear the fault, it only hides the pop-up message.

When a fault code has been hidden, a “Show” icon will remain in the bottom right corner. When this soft key is pressed, the fault code will again be displayed.



Scrolling Through Multiple Messages

The title-bar of the fault code pop-up may indicate multiple messages, as in ‘Diagnostic Message 1 of 3’. Press the HOME Display to scroll through the different messages.



Utilities

The Utilities menu provides tools to configure wiring and communication settings, and default settings for adjusting the ballasts and Smartplate.



Soft Key Commands located throughout Utilities include:
UP – DOWN – changes the value of the current field.
PREV – NEXT – moves from field to field.
RESTORE DEFAULTS - Loads the factory defaults after displaying a confirmation warning.



SAVE/EXIT – saves the current values and exits.

System Settings

The System Settings screen displays the current software version loaded on the unit. It is typically only accessed when the unit is first installed in order to configure the unit. You can set individual settings for the available options, or choose to select **RESTORE DEFAULTS** for the factory settings.



Default Settings

This screen provides various fields for adjusting the values for ballast and Smartplate. The Smartplate Crossover point also defines the threshold for setting the automatic audio volume control.



GPS Utilities

When using a GPS device, GPS Utilities will allow you to configure and monitor satellite tracking data.



Satellite Status

This feature displays a graphic indicating the satellites currently visible in orbit and the signal strength of each satellite.

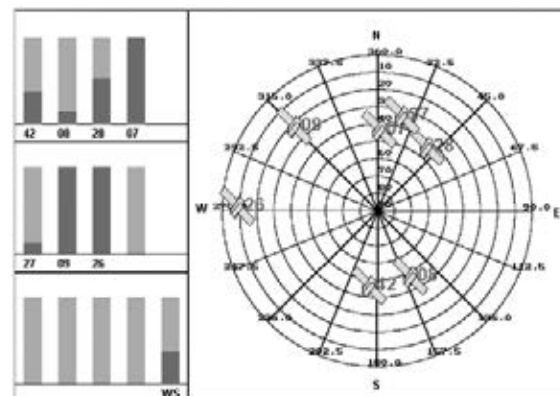

Depth and Position Setup

This feature allows you to define the amount of detail to display for longitude and latitude information on the GPS map and depth display.



Chart and Time Setup

This menu option allows you to set up viewing options for the GPS Display.



Chart Setup Parameters – use the **CHECK/UNCHECK** soft key to select the information you want displayed on the GPS screen.

Time Setup Parameters – is used to select correct time zone and clock mode for either 12-hour or 24-hour time formats. You can also enable DST (Daylight Savings Time) by using the **CHECK/UNCHECK** soft key to select the box.

Waypoint Manager

Waypoints allow you to mark specific locations by latitude and longitude. Once the waypoints are established, the Waypoint Manager allows you to associate an icon with them for identification. You can delete a single waypoint by using the **DELETE** key, or all of them at once with **DELETE ALL**. Pressing the **GO TO WPT** key displays the GPS screen containing the currently highlighted waypoint.



Waypoint List – displays a list of the waypoints that have been set. Use the **UP** and **DOWN** keys to highlight the desired waypoint.

Waypoint Icon – allows you to assign one of four different icons to any of the waypoints listed.

Lat/Lon – Displays Latitude and Longitude values for the currently highlighted waypoint on the list.

Track Manager

You can set up multiple tracks for displaying on the GPS map. The Track Manager allows you to select tracks to 'show' on the map or 'hide' a map you are not currently using. You may **DELETE** one track or 'Delete All Tracks' at once.



Supra VISION General Troubleshooting Guide

Display appears not to work or doesn't come "ON".

1. Display could be in sleep mode. Touch a key on the keypad to activate the display.
2. Check for loose connections at battery and display unit.
3. Check for reversed polarity on the power connections.
4. Verify battery has a minimum voltage of 6 Volts.

Display resets or goes "OFF" when starting engine.

1. Check display supply wires are connected properly to battery.
2. Verify battery is charged properly.
3. Check battery for efficient starter current.

Display has no backlight.

1. Contact your Supra service center.

Display has no keypad backlight.

1. Contact your Supra service center.

Supra VISION Dash USB Data-Link

The VISION Dash USB Data-Link is located on the lower starboard side of the dash. This port is used for communication with the VISION dash processor. Two types of USB ports were used.

NOTE: This is not a stereo input.



Stereo



Please refer to your stereo owner's manual for proper operation instruction.

NOTE: Stereo unit is connected to the Stereo switch on the switch panel. The "Stereo" switch must be in the "ON" (lighted) position before the stereo can be turned on.

NOTE: On some Supra models the key switch has to be in the "ON" position in order for the dash stereo switch to be powered. On these models when the key switch is in the "OFF" position, no power is available to the dash switches.



SUPRA STANDARD PACKAGE*



NAVIGATION LIGHTS SWITCH
Provides power to the bow light, stern light, and anchor light. The three positions of this switch are up (navigation lights), center (off), and down (anchor light).



STEREO SWITCH
Provides power to the stereo unit. The switch must be turned on before the stereo can be played.



COURTESY LIGHTS SWITCH
Provides power to the interior lights located throughout the boat.



ACCESSORY SWITCH (LEFT)
Provides power to an extra circuit. This switch is used for the optional factory installed docking lights.



ACCESSORY SWITCH (CENTER)
Provides power to an extra circuit. This switch is used for the optional factory installed tower lights.



ACCESSORY SWITCH (RIGHT)
Provides power to an extra circuit. This switch is used for the optional factory installed underwater lights.



LEFT BALLAST SWITCH
Provides power to the left (port) ballast bag. The three positions of this switch are up (fill), center (off), and down (empty)



CENTER BALLAST SWITCH
Provides power to the center ballast. The three positions of this switch are up (fill), center (off), and down (empty)



RIGHT BALLAST SWITCH
Provides power to the right (starboard) ballast bag. The three positions of this switch are up (fill), center (off), and down (empty)



ACCESSORY SWITCH
Provides power to an extra circuit. This switch is used for the optional factory installed heater.



DRIVER'S SEAT
Provides power to raise or lower the driver's seat.

NOTICE

If any lights, bilge, stereo, courtesy lights, or accessories fail to operate, press the appropriate circuit breaker located under the switch.

NAVIGATION LIGHTS

When underway during night time operation, set the switch in the NAV position to activate all of the running lights.

When docked or at anchor, set the switch in the ANC position to activate only the pole light.

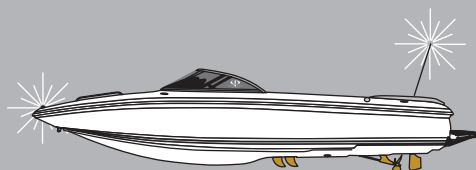

NAV LIGHTS

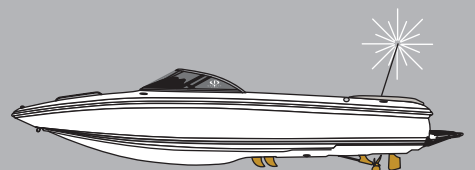

ANC LIGHTS



*Switch configuration may vary slightly based on options. If you have any questions regarding operation, please contact your dealer or Skier's Choice, Inc.



Ignition Switch



Located on the port side of the dashboard, the ignition switch has four positions. In the vertical position the ignition is "OFF". In the OFF position, only the blower and bilge switches are powered.

One position counterclockwise is the "ACC" position. This will power the dash switches.

One position clockwise is the "ON" position and this will power the switches and energize the motor.

The full clockwise position is the "START" position.

NOTE: All electrical equipment should be turned off when the boat is in storage.

Horn Button



The Horn Switch is located on the port dash panel near the ignition. Sound the horn by depressing the button.

Blower Switch



The blower switch activates the blower motor. The primary function of the blower fan is to remove any fumes from the bilge area. The blower also draws fresh air into the engine compartment.

Never depend solely on the blower to eliminate dangerous fumes. Before starting the engine, always open the motor box to check if fumes are present. Switch on the blower fan a minimum of four minutes before starting the engine.

NOTICE: If the blower fails to operate, reset the circuit breaker. If the blower still does not operate, notify your Supra dealer.

⚠ DANGER

Failure to operate the blower in accordance with the Coast Guard Recommendation could result in an explosion.

Horn/Whistle Signals

One Long Blast:

Warning Signal (Coming out of slip)

One Short Blast:

Pass on my Port Side

Two Short Blasts:

Pass on my Starboard Side

Three Short Blasts:

Engines in Reverse

Four or More Blasts:

Danger Signal

1. OVERTAKING / PASSING: Boat being passed has the right-of-way. KEEP CLEAR.
2. MEETING HEAD-ON: Keep to the right.
3. CROSSING: Boat on the right has the right-of-way. slow down and permit him to pass.



Tilt Steering



Tilt steering may be adjusted up or down in five different locking positions. To adjust, depress the tilt lever located beneath the bezel and move the steering wheel to the desired position. Release the lever to lock the wheel into place.

Safety Lanyard/Engine Shut Off Switch



Your Supra is equipped with a Safety Lanyard/Engine Shut Off switch. In order for the engine to run, the plastic tip of the safety lanyard must be attached to the switch. If the clip is removed from the switch, the engine will not run.

⚠️ WARNING

Avoid serious injury or death. Attach Safety Lanyard to driver prior to operating boat.

V-Drive Warning Light



The V-Drive transmission in your Supra is equipped with a "low pressure" warning light. This light is located by the dash. Do not operate your Supra if the warning light remains on, whenever the engine speed is above, 1,200 RPM (+/- 400 RPM). This warning light should be on whenever the engine speed is below 1,200 RPM (+/- 400 RPM). If this light remains on during operation above idle, shut your engine off immediately and check your v-drive oil level and see your dealer.

Circuit Breaker Panel

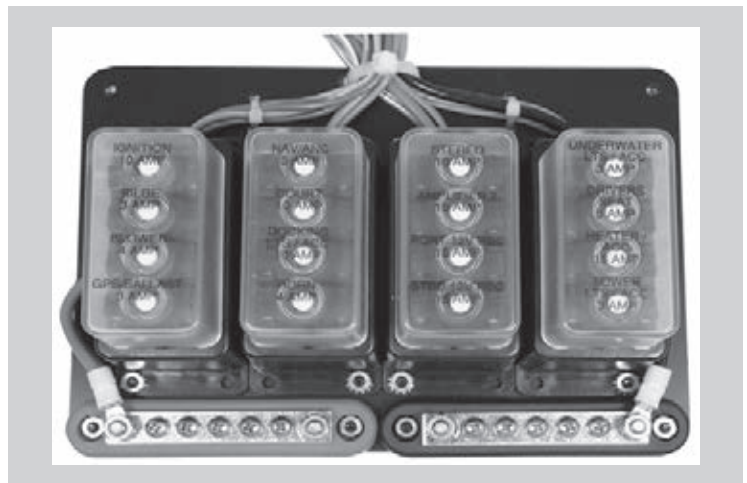

The circuit breaker panel contains breakers for all electrical equipment. The panel is located below the dashboard on the side wall nearest the driver's left knee.

If a switch fails to operate, locate the corresponding circuit breaker and press the reset button. If the equipment still does not operate, notify your Supra dealer.



Gravity Ballast System

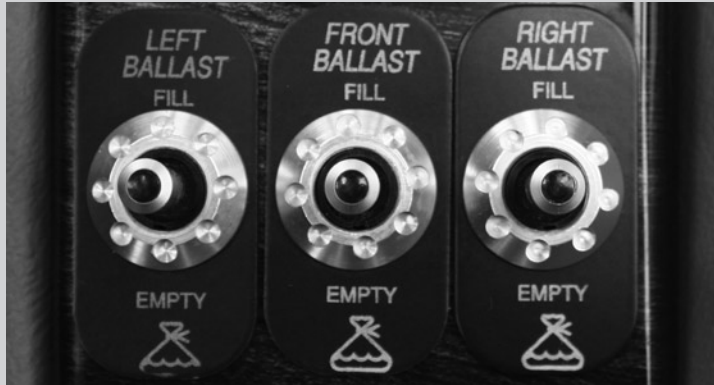

The Gravity Ballast System in your boat is an electronically controlled ballast system that can be operated from the driver's seat. The system can be controlled by using the ballast switches or through the Supra Vision Dash. The Supra Vision Dash allows for stored preset ballast levels (see "User Preset Screen" in the Vision System section of this Owner's Manual) for easy rider setup. The manual switches for this three position system are located in the switch panel directly below the shifter mechanism.

The Ballast System in your boat is an integrated and logically controlled system. At the heart of the system is a series of reversible pumps that use impellers to pump water in and out of the ballast system. The controller for the system runs the pumps an appropriate amount of time to fill and to empty the bags.



CAUTION When bags begin to vent, shut off!

WARNING Do Not overfill ballast bags!



Filling the System-In normal operation of the system, flipping one of the switches to "Fill" will start the system filling the associated ballast. The ballast gauge on the Supra Vision system will turn green. The pump will automatically turn off when the appropriate amount of time to fill the system has been reached. The light on the switch will still be luminated as it is in the "Fill" position, but the pump will not be running. The ballast gauge on the Supra Vision system will turn yellow. The switch should be turned back to the "off" position when the pump stops running.

Emptying the System-In normal operation of the system, flipping one of the switches to "Empty" will start the system emptying the associated ballast. The ballast gauge on the Supra Vision system will turn green. The pump will automatically turn off when the appropriate amount of time to empty the system has been reached. The light on the switch will still be luminated as it is in the "Empty" position, but the pump will not be running. The ballast gauge on the Supra Vision system will show empty. The switch should be turned back to the "off" position when the pump stops running.

Ballast Pump Impellers- The pumps that fill and drain the ballast system use an impeller. Your Supra ballast impeller uses the latest polymer technology in an effort to have the longest service life possible. The impellers are a wear item and different use patterns, water types, debris, etc. can greatly affect the service length of the impeller. As the impellers wear, the amount of water that is pumped into and out of the ballast system is reduced. The Vision System does have provision for adjusting fill and empty times to accommodate decreased efficiency due to impeller wear or changing to difference sized bags (See Vision Dash "System Settings" For more info). Running the pumps without water will greatly accelerate the wear and prolonged running of the pumps without water will damage the impeller to the point that they will require immediate replacement. Note: Impellers are a wear item and not covered by warranty. Ballast System Utilities- It is not recommended to change any of the ballast configuration that are found under the "Utilities" menu on the Vision Dash unless specifically directed to do so by your Authorized Supra dealer. Changing these values may negatively affect the ballast system or may make the system fail to work all together.



2012 Ballast Trouble Shooting Guide

Ballast Switch LED Light Blink Codes

Blink Code	Cause	Reason	Correction
One Blink	Pump has run dry	Tanks empty or no water at inlet	Pump will shut down in approx. 15 seconds and will not restart until switch is cycled off.
Two Blinks	High Amperage draw from pump	(1) Line blocked, pump stalled (2) Low battery voltage (3) Turning on all the pumps at the same time.	(1) Pump will shut down immediately and not restart until switch is cycled to off. If problem persists, unit will shut down immediately again until problem is resolved. (2) Check the battery voltage. Have engine running when turning on the pumps. (3) Turn the pumps on one at a time.
Three Blinks	Power loss between the module and the pump	Open condition, winding breaks, power removed between control module and pump.	Module will shut down after 10 seconds of loss of power between module and pump and will not restart until cycled.
Four Blinks	Low voltage	Pump will not start if power at control module is less than 10.5 VDC	Charge battery and/or run boat engine while filling ballast.
Six Blinks	Timer limit	Programmed limit	Control module has reached programmed or maximum run time. Additional ballast can be added (bumped) in 1 minute increments by pressing FILL. This will add extra water to ballast but will not effect program time.

Problem	Possible Cause	Action	Correction
Pump will not turn on, no blinking light at switch	Ballast power wires not connected to battery	Check ballast power wires at battery	Connect power wires to battery
Pump will not turn on, no blinking light at switch	Ballast breaker is tripped	Check 60 amp ballast breaker at the battery	Reset ballast breaker at battery
Pump will not turn on, no blinking light at switch	System needs reset	Check power to all areas	Turn power off to the system at the breaker and then back on and retry
Pump turns on, but does not pump water	Pump not priming	(1) Water intake ball valves are not open (2) Kink in hose	(1) Open ball valves (2) Check hoses for kinks and straighten as needed (3) Check hose connections and tighten if loose.

DC Outlet

2012 Supra Ballast Fill Times

Boat Model	Front Ballast	Rear Ballast Time
20V	3 minutes	4.5 minutes
21V Walk-Thru	3 minutes	4.5 minutes
21V Play-Pen	4 minutes	4.5 minutes
22V Walk-Thru	3 minutes	4.5 minutes
22V Play-Pen	4 minutes	4.5 minutes
242 Walk-Thru	3 minutes	4.5 minutes
242 Play-Pen	11 minutes	4.5 minutes



For your convenience, a DC outlet has been included on the panel to the right of the driver's seat. Some models have receptacles located in the glovebox. Location varies by model.



Ignition Keys

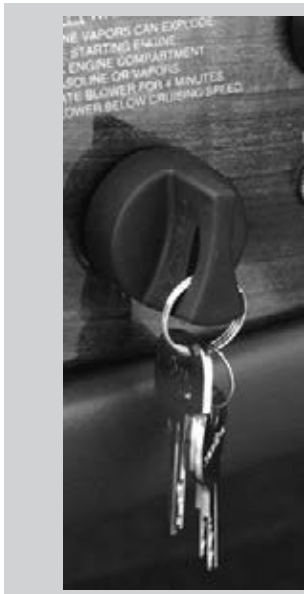

Two ignition keys are provided with the boat. Key entry into the ignition may be difficult due to the boot protector. Please, do not unduly force the key into the ignition. Key tumblers are located vertically, thus the key should be vertical when placed into the switch.

NOTE: Always attach the ignition key and gas key to a floating key chain to prevent loss in the water.



Fuel Cap



NOTICE: The gas cap is sealed by a rubber O-ring. Do not over tighten!

CAUTION

Always attach the ignition key to a floating key chain to prevent loss overboard.

Mirrors

The rear view mirror is installed as a standard item. The mirror is adjustable and is not permanently placed so that it may be set for each driver.

- Mirror should always be checked before driving.
- Mirror angle will change with each new driver.



Windshield Mounted Mirror

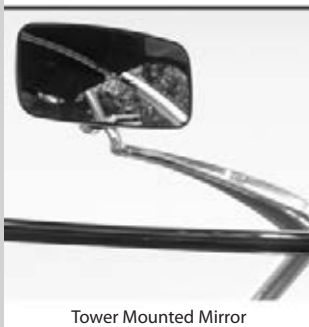

Tower Mounted Mirror



Optional Wide Angle Mirror



Driver's Seat & Seat Adjustment



The Rise-R Seat is a unique driver seat enhancement. The front edge of the driver's seat cushion lifts up to give the driver a taller sightline.

CAUTION

Be careful of the articulating hinge. Do not place fingers or other objects in the hinge mechanism during use.

The driver's seat may be adjusted forward or backward by moving the lever below the side of the seat. Use body pressure to move the seat to the desired position. Release the lever then check to feel the seat lock into place.

The driver's seat may be swiveled by pressing the button on the side of the seat.

Adjustable Seat Height

To adjust seat height (if applicable) slide the lower release handle forward and adjust seat to the appropriate height. Release the handle and it will lock into place.

CAUTION

After adjusting the seat, be sure that it has locked into place by pushing forward and backward until it has securely latched.

DO NOT attempt to adjust the driver's seat while the boat is moving.

Ensure that seat swivel is locked prior to driving boat. Do not swivel seat while boat is in motion.

V-Drive Engine Compartment

To access the engine compartment, turn latch and pull to raise the center sun deck lid. When the ski lockers and engine compartment lids are closed, the upholstered lids double as a cushioned sun deck.

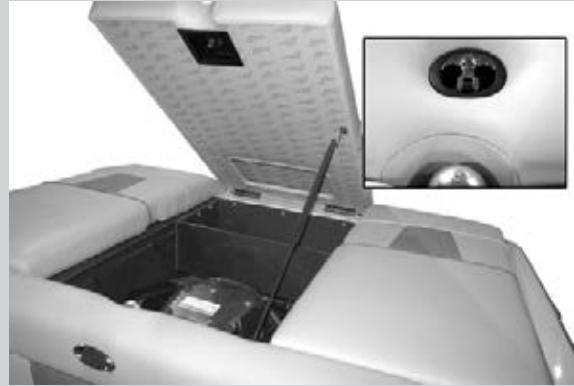

Pulley & Belt Warning!
Pulleys and belts can cause severe injury! Never open the motor box while the engine is running or while the boat is underway!
Remember, after running, the engine is extremely hot and should not be touched or repaired until it has cooled.



Fire Extinguisher



A standard United States Coast Guard approved fire extinguisher is provided with your Supra boat. The fire extinguisher is usually located under the observer's seat cushion, however, locations vary by boat. You should know the exact location of your boat's fire extinguisher in case of an emergency.

NOTICE: Refer to the instructions on the fire extinguisher for proper use.

Flame Precautions

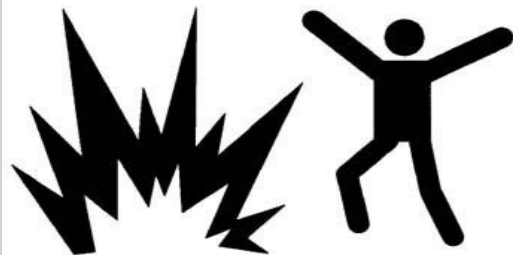

⚠️ WARNING

Sparks while fueling can cause explosion! Extreme caution should be taken when an open flame is present on board. Fumes from the engine and fumes from the battery are highly flammable. No flame or spark should come near these areas.

⚠️ WARNING	
	<ul style="list-style-type: none">• AVOID SERIOUS INJURY OR DEATH.• LEAKING FUEL IS A FIRE AND EXPLOSION HAZARD.• INSPECT SYSTEM REGULARLY. EXAMINE FUEL SYSTEM FOR LEAKS AND CORROSION AT LEAST ANNUALLY. <small>WLENG2863</small>

V-Drive Ski Pylon



The ski pylon is to be used to pull skiers. DO NOT use ski pylon to hoist boat! Only use the lifting rings for this purpose.

To use, pull pylon up, twist counterclockwise and push back down into the lock position. To retract, pull pylon up, twist clockwise and push down to storage position.

⚠️ WARNING

DO NOT mount any Pylon Extension on the rear pylon (located at the rear sundeck).



Supra Tower

If your Supra model has been equipped with a tower, please review this section for details on its usage, maintenance and storage. The cage is designed as a stable tower to enhance wakeboarding. It is NOT intended to be used to tow skiers, barefoot skiers, or multiple wakeboarders. Such use will void any warranties written or implied.

⚠ WARNING

Before use, be sure that all mounting bolts are properly tightened in place.

⚠ WARNING

Be aware of and avoid low overhead objects such as bridges, power lines, overhanging trees, etc.



Progressive Tower

To lower the tower, remove the hand knobs from the front of the stationary arm. The tower folds backwards toward the sundeck. To raise the tower, pull the tower up and forward until the forward leg engages into the locating pins. Install and tighten the locking hand knobs.



To Raise Tower

- Lift the tower and swing up the rear legs. Install the four hand knobs.

⚠ CAUTION

The threads in the aluminum foot could be damaged if the bolts are not aligned and threaded correctly.

⚠ WARNING

The tower is designed to pull a single (1) wakeboarder, trick skier, or kneeboarder.

NOTE: Apply a thin coat of anti-seize to the threads of the hand knobs periodically.

To Lower Tower for Storage

- Remove the four hand knobs from the top of the rear leg. While holding the tower up, lower the side legs. Then lower the tower downward into the boat.

20V Rail Tower



Tower Navigation Light



Boats equipped with factory installed towers have the 360° White Pole Light mounted on the tower. The light can be illuminated by the "NAV" switch located on the panel.

Bow Light



The bow light is located on the bow of the deck at the front of the boat. To alert other boaters to your position and direction, the light is green on the starboard side and red on the port side. The bow light is activated by the "NAV" switch.

Courtesy Lights

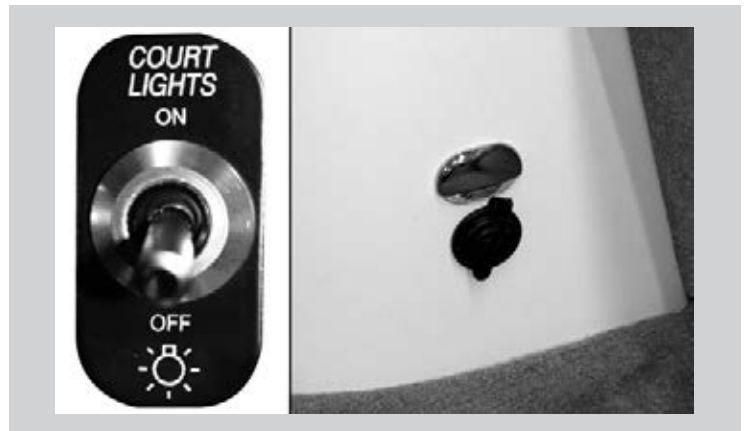

Courtesy lights are installed at several locations in the interior of the boat. The courtesy light switch is located on the instrument panel and is marked "COURT".



Lifting Rings

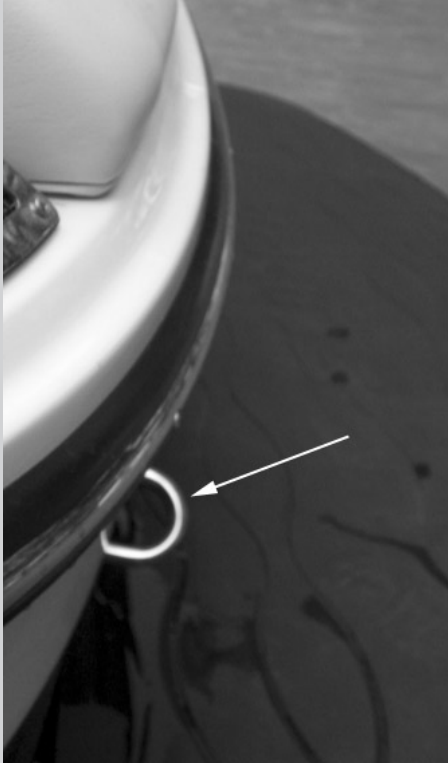

Two lifting rings are located on the transom.

Bow Eye

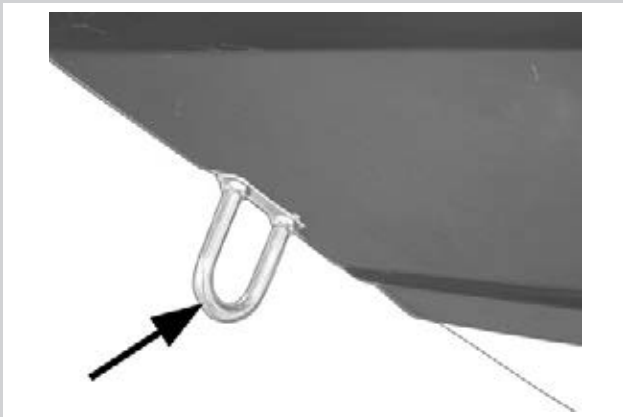

The bow eye is located at the front of the hull below the rub rail. It is the point of the attachment to lead the boat onto the trailer and to secure the boat to the trailer or to tie-off when docking.

Ski Platform



The transom mounted ski platform allows easy access to and from the water for skiers and swimmers.

It is recommended that entries to and exits from the water be made from the platform to avoid accidents. (The fiberglass deck can become slippery when wet)

DANGER

Shut off the engine when people are on the platform or in the water near the platform.

DANGER

Exhaust fumes contain carbon monoxide. Direct or prolonged exposure to carbon monoxide will cause brain damage or death.

NOTICE: Do not use the bow eye ONLY to hoist the boat. You must use a sling with the bow eye when hoisting the boat. (See Hoisting Instructions)

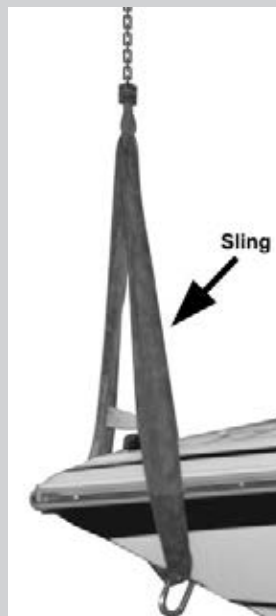

Detachable Bracket



The ski platform is attached to the boat with detachable brackets. The platform may be removed from the boat by pulling the retaining pins from the brackets and lifting up and out.

Ski Locker



Ski storage, depending on the model of Supra you own, is located either between the observer's seat and driver's console or in the rear of the boat. On storage found between the driver and observer's console, simply unstrap the strap and lift to open.

Center Sundeck Walk Across



The center walk across panel is a convenient way to move from the cockpit of the boat to the sundeck.

The center seat cushion/ step allow the owner use the center seat in two ways. With the pad snapped in, the center cushion acts as a seat. If you unstrap the pad to expose the step, it becomes a convenient way to enter the cockpit. The pad is intended to be either covering the step and used as a cushion or removed to use the step.



Sundeck



When the ski locker is closed, the upholstered lid doubles as a cushioned sun deck.

Propeller



The research and design team at Skier's Choice has carefully explored and tested many different propellers and pitch angles for use on our boats. All tests indicate that the current propeller installed on your model is the best for the variety of boating performance required, whether skiing competitively or for pleasure.

It is strongly recommended that your Supra dealer be notified before changing the propeller. In general, changing to a lower pitched propeller may increase acceleration, but will decrease top speed. Changing to a higher pitched propeller may achieve higher top speed with a light load, while acceleration and power may decrease.

CAUTION

Avoid engine damage. Do not exceed the maximum RPM as listed for your motor. Some props may allow the engine to over rev, which can cause non-warrantable engine damage.

PROPELLER PRECAUTION!



A moving propeller will cause injury. The propeller may turn with the boat in neutral. Shut off the engine while skiers or swimmers are in the water near the ski platform.

NOTICE: Under no circumstances should a propeller be used which allows the engine to exceed manufacturer's recommended RPMs.

Double-Up Seating



Some Supra models offer Double-Up Seating. This unique seating can be stored flat for easy access to the bow or flipped up for extra rear and forward facing seating. To use this seating, lift and pull the seat back into the locked position. Be sure that the metal arms are locked before applying pressure.



To lay seat back down, simply pull the seat section of the backrest more upright to release the locking mechanism.

Triple-Up Seating

Both the 22 and 24 Series boats have "Triple-Up" seating. This unique type of seating can be stored flat or flipped up for extra rear facing seating. To use this seating, lift and pull the seat back into the locked position. Be sure that the metal arms are locked straight before applying pressure. To lay seat back down, simply push the lever section of the metal support arm to release the lock mechanism.



Wake Plate



The wake plate allows the driver to control the running attitude of the boat. It can be controlled by the switch on the dashboard.

Trim Switch



This switch controls the wake plate. The gauge indicates the position of the plate.

Walk-Thru Windshield



The movable center windshield panel allows access to and from the bow deck. To open, turn safety latches to vertical and push. Lay the center windshield panel gently against the fixed side panel.

Billet Glove Box



To open the glove box, press the button on the door. To close the lid, simply push the lid back until it latches.



Optional Boat Heater



The boat heater is a forced air heater that uses hot engine water as a heat source. To use the heater, simply turn the heater switch to the selected fan speed. In order for the heater to work, the engine must be at operating temperature. One of the features of the heater are the snorkel vents, which can be pulled out to direct heat to specific areas.

NOTE: Location varies by model.



Optional Bimini Top Styles



Forward Bimini

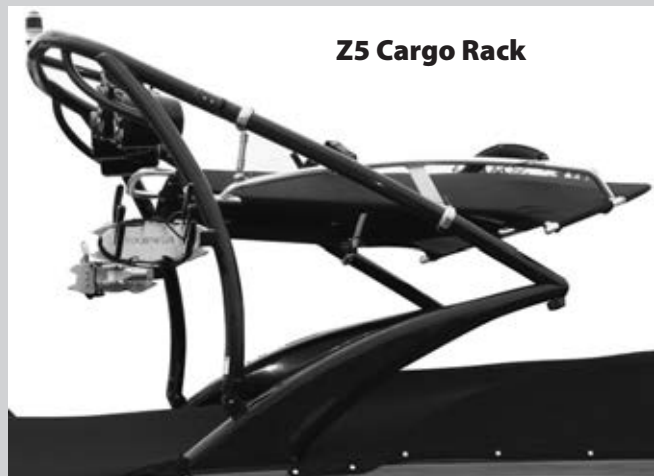

Z5 Cargo Rack

The bimini top is designed as a sunshade. Please see the mooring cover section for instructions on cleaning and caring for your bimini top. When opening and latching the straps to the eye hooks, twist the strap one to two times to prevent them from vibrating in the wind.

⚠ CAUTION

DO NOT tow the boat above 45 MPH with the bimini top open or the Z5 canvas on the frame. Damage to the canvas may occur. This type of damage is not warrantable.



Battery Box



The battery is mounted inside the observer's seat storage compartment. Location may vary slightly depending on the model.

NOTICE: It is recommended that the battery cables be disconnected from the battery when the boat is placed in storage.

CAUTION

Avoid damage or injury from battery acid. Ensure that the battery is properly secured before using boat.

Dual Battery (Option) Hookup

The optional dual battery setup is designed to create a redundant system allowing the user to have a back up battery. The switch must be used in the "1" or "2" position to create the redundancy.

To properly hook up the two batteries;

1. Connect the grounding strap provided from the negative (-) post on Battery 1 to the negative (-) post on Battery 2.
2. Connect the negative (-) cable from the grounding buss bar to the negative (-) post on Battery 1.
3. Connect the negative (-) cable from the engine to the negative (-) post on Battery 1.
4. Connect the positive cable from the left side of the battery switch to the positive (+) post on Battery 1.
5. Connect the positive cable from the bottom of the switch to the positive (+) post Battery 2.

Battery 1 is designated as the primary battery and Battery 2 is designated as the secondary battery.

The battery selector switch has four positions; Off, 1, 2, 1&2.

- The "Off" position cuts all power to the boat except to the bilge pump and stereo memory.
- Position "1" only allows power to be drawn from or charged to Battery 1.
- Position "2" only allows power to be drawn from or charged to Battery 2.
- Position "1&2" allows power to be drawn from or charged to both batteries.

CAUTION! - Do not turn the selector switch to the "Off" position when the motor is running. The alternator will be permanently damaged and is not covered under Skier's Choice or Indmar warranty.

It is highly recommended that Position "1" be used in most situations so the secondary battery will be available to start the engine from Battery 2 (secondary) if necessary.

Be aware that if position "1&2" is selected, both batteries will drain power at the same time and could leave you stranded due to weak batteries.

NOTE: It is recommended that you fully recharge your batteries using a battery charger periodically or after a period of high discharge (running many accessories for an extended period of time).

NOTE: Skier's Choice highly recommends using quality "Dual Purpose" batteries.

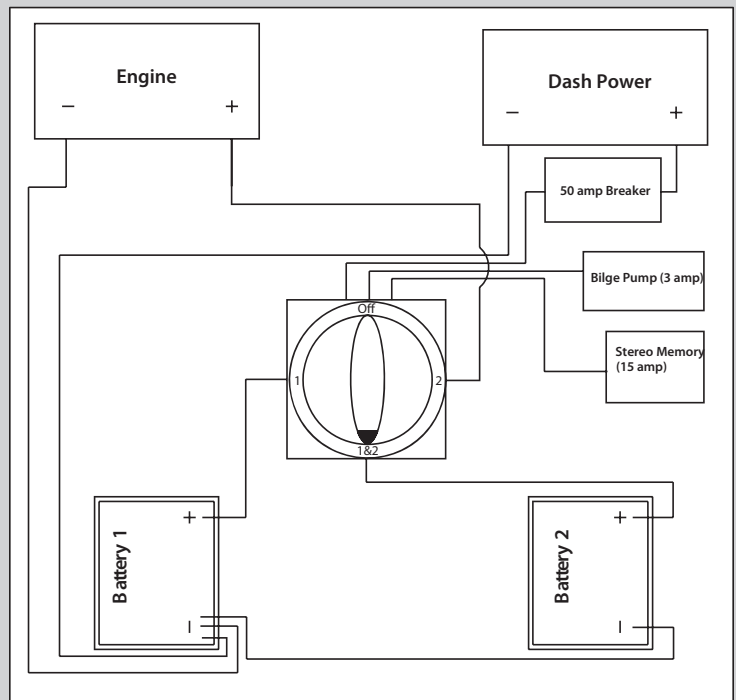

Cooler



Some Supra models offer built-in coolers. They have drain holes that drain water into the bilge. Be sure to thoroughly clean the cooler and allow it to dry after each use to prevent mold and mildew.

Wakeboard Racks



CAUTION

Place wakeboard swing arm in the 0 degree position with pin in place prior to putting the boat in gear.

Wakeboard racks are a convenient way to transport and store wakeboards while using your boat.

Supras have swing arm wakeboard racks for easier loading and unloading of boards. The swing arm has a stop at 0, 90, and 180 degrees. To operate, pull the pin and rotate the wakeboard rack. Reinstall the pin to ensure rack does not rotate unexpectedly.

CAUTION

- Place wakeboard swing arm in the 0 degree position prior to putting the boat in gear.
- Check tightness of all mounting hardware before each use.
- DO NOT trailer the boat with wakeboards mounted in the racks.

Optional Tower Speakers



The optional tower speaker and light bar combo is a unit that houses both an additional set of tower speakers and lights. The speakers are designed to allow the rider to be able to hear the music. The tower speakers require the addition of an amplifier to power the speakers. The tower lights are designed to make docking, loading and unloading easier. The tower lights require the addition of a dual-battery electrical system.

NOTE: Tower lights are not to be used as running lights at night. USCG regulations mandate that a boat under power after sunset must display a 360 degree white light and a red/green bow light.

WARNING

It is illegal to wakeboard, ski, tube, etc., after sunset and before sunrise in most states. It has been outlawed because it is dangerous. Tower lights do not make these activities legal or safe.

CAUTION

Some lakes have noise restriction ordinances. The use of tower speakers may not be allowed in your area. Please check all applicable laws in your area regarding noise level restrictions.

Transom Mount Stereo Remote



The optional transom mounted stereo remote allows the stereo to be controlled from the rear of the boat.

DANGER

Keep away from rear of boat while the engine is running. Do not be on or about the swim platform while the engine is running or the boat is in motion.



Optional Mooring Cover



Your Supra boat cover is made from the finest canvas and webbing to ensure that your boat will be protected in the off season. The cover has been designed to fit securely around each boat.

Use the following procedure when covering the boat:

1. Be sure that the cover fits snugly at the bow then unfold from front to back.
2. Be sure to install cover pole(s) and adjust to proper height, using set screw on pole(s). This will keep water from gathering in the center, which can damage the cover.
3. Secure all fastening straps around the trailer frame.
4. Use the ratchet system to tighten the drawstrap.

Folding Cover

When folding the cover for storage, be sure the cover is dry. Take care not to scratch the canvas finish against rough surfaces. Store in a dry location.

Cover Repair

If the cover becomes damaged, immediately patch and reseal the area. Use a tent seam sealer to reseal any new stitches. Spray fabric guard on scraped or worn surfaces. Canvas tears should be repaired professionally and stitches sealed to prevent leakage.

CAUTION

DO NOT trailer the boat with the mooring cover installed. This type of damage IS NOT covered by your boat warranty!

Optional Tonneau Cover



The optional tonneau cover is designed to snap over the bow of the boat. Its purpose is to minimize air flow into the cockpit area when the boat is in use and as a storage cover when used in combination with the optional cockpit cover.

CAUTION

DO NOT trailer the boat with the tonneau cover installed. The tonneau cover is not designed as a trailer cover and may come unsnapped or rip. This type of damage IS NOT covered by your boat warranty!

Optional Cockpit Cover



The optional cockpit cover is a snap down storage cover designed to help protect the interior of your boat. To install the cover, start at the windshield and work towards the transom. Be sure to install the cover poles to prevent water pocketing.

CAUTION

DO NOT trailer the boat with the cockpit cover installed. The cockpit cover is not designed as a trailer cover and may come unsnapped or rip. This type of damage IS NOT covered by your boat warranty!



Stereo Amp



The stereo amplifier is an optional piece of stereo equipment that is designed to increase the wattage of the signal going to the speakers while minimizing distortion of this signal. Please see stereo amplifier owner's manual for more information.

CAUTION

Using a stereo amplifier without boat engine running may drain the battery to the point where the boat will not restart. This condition may happen very quickly, depending on the size of the battery.

Optional Subwoofer



The optional subwoofer is designed to increase the sound level of the bass notes. The amplifier powers the subwoofer. The bass level can be adjusted on the amplifier. Please see stereo amplifier owner's manual for more information.

Optional Satellite Radio



The optional satellite radio is designed to give the user music access anywhere they go in North America. The system is a 100 channel system which is broken down into different music types such as: oldies, hard rock, easy listening, alternative, 80's, jazz, big bands, etc. This system does have a minimal subscription fee that must be paid annually to continue service. Please see satellite radio owner's manual for more information.

NOTE: Location of satellite antenna may vary by model.

Air Inflator



The models with steps come standard with an air inflator. It is a high volume, low pressure pump designed specifically for tubes, air mattresses, etc. To use the pump, pull the unit out of its storage compartment located to the rear of the walk through area and plug the cord into the 12 volt receptacle. Connect the hose of the inflator to air input on inflatable object and turn on.

CAUTION

DO NOT leave air inflator running unattended.



Optional Water Strainer



The optional engine water strainer is a filter for the engine cooling water. It is recommended for boats that are going to be operated in weedy conditions or other areas where debris could clog the engine. It consists of a stainless steel mesh filter inside a clear cup. It is located between the water intake on the bottom of the boat and the engine's raw water pump. It should be checked periodically for debris as conditions dictate. To remove debris, unscrew the clear sight cup, remove the o-ring and stainless steel mesh filter and proceed to rinse out the cup. Be sure to reinstall the mesh filter and o-ring before reattaching the sight cup to the inlet.

Optional Walk-Through Curtain

Some Supra models offer an optional walk-through curtain that snaps into the front walk-through to help prevent cool air from flowing into the cockpit area.

Optional Fresh Water Cooling System



The optional fresh water cooling system has a heat exchanger which allows the engine to have an antifreeze mixture which circulates in the engine. For more information, see your engine owner's manual.

Optional Fresh Water Flush

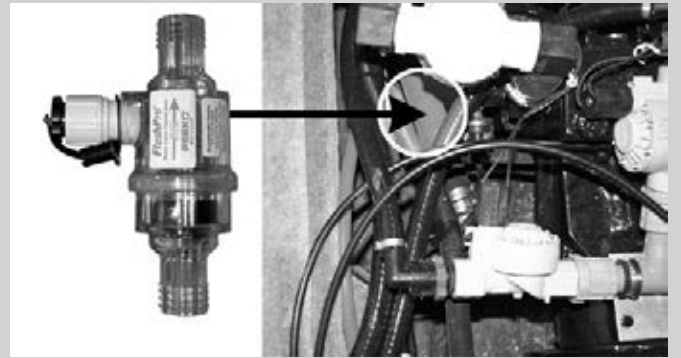

The optional Fresh Water Flush kit is a valve specifically designed to allow you to attach a garden hose to your engine water intake to flush brackish or salt water out of your engine. To use the Fresh Water Flush, simply attach a garden hose to the valve. Turn on the water to the valve. Start the engine. Monitor the exhaust ports on the transom of your boat and engine temperature gauge. Water should come out of the exhaust ports while the engine is running. It is recommended that you run the engine at a low RPM while flushing, since the engine's raw water pump at higher RPMs can pump more water than the garden hose can supply. If you have questions on the operation of your Fresh Water Flush kit, consult your Supra Dealer.



Fuel Precautions



WARNING

Sparks while fueling could cause an explosion!

Before Fueling:

1. Turn off engine.
2. Turn off all electrical systems.
3. Extinguish cigarettes or any open flame.

While Fueling:

1. Keep fuel hose nozzle in contact with fill pipe to provide grounding.
2. Fill tank at a slow rate to avoid spills.

Filling the Tank



NOTICE: Pay careful attention when filling the fuel tank. **DO NOT** overfill the tank! Fuel may empty through the fuel vent and damage the outside finish.

If fuel is spilled on stripes or decals, apply a common bath cleaner (non-abrasive) and wipe with a damp cloth. Rinse spill area with clean water.



Fuel Fill

The fuel cap is located in the middle of the rear of the boat. To remove cap, flip the tap down and twist off counter-clockwise.

NOTE: The cap is sealed by a rubber o-ring. Please do not overtighten.

NOTE: The 21V, 22V and 24V Series boats, for extra convenience, have a fuel fill on both sides to allow for easy fueling.

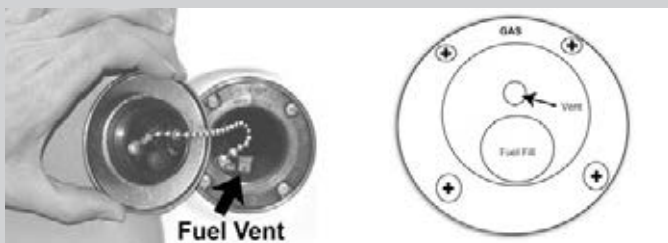

Fuel Vent

The fuel vent is a part of the gas filler neck. This vent is connected to the fuel tank via the vent hose, which releases gasoline fumes from the fuel tank.

CAUTION

Gasoline vapors are highly explosive.



Fuel Tank Pump



Your boat contains a fuel system that is designed using current fuel delivery technology. The common terminology for this type of system is: Pump in Tank.

The system consists of a dual high pressure pump canister that is mounted inside the fuel tank. On the top of the canister there is a fuel pressure regulator. The engine's fuel lines are connected to the in tank fuel pump via a specially designed shielded, flexible high pressure fuel hose. This hose is pressurized. This system requires special tools and knowledge to service and maintain and as such is not owner serviceable.

The fuel filter for the boat's fuel delivery system is in the fuel tank. This style filter system is considered a lifetime filter under normal circumstances.

The pump in tank fuel delivery system uses the fuel to lubricate and cool the fuel pumps. Running the pumps with very low fuel levels or running the pumps without fuel in the tank can induce air into the pumps which may shorten the fuel pump's longevity. This type of fuel pump damage is not warrantable.

The following USCG information is important to your safety and safe operation of the boat:

"THIS BOAT COMPLIES WITH U.S. COAST GUARD SAFETY STANDARDS IN EFFECT ON THE DATE OF CERTIFICATION WITH THE EXCEPTION OF CERTAIN FUEL SYSTEM REQUIREMENTS ASSOCIATED WITH ITS FUEL INJECTED ENGINE AS AUTHORIZED BY U.S. COAST GUARD GRANT OF EXEMPTION (CGB 09-003). MAINTENANCE OF THE FUEL SYSTEM IN THIS BOAT SHOULD BE PERFORMED ONLY BY EXPERIENCED TECHNICIANS USING IDENTICAL FUEL SYSTEM COMPONENTS."

"SERVICE OF THE ENGINE INSTALLED IN THIS BOAT REQUIRES SPECIAL TOOLS, TRAINING AND GENUINE REPLACEMENT PARTS WHICH ARE ONLY AVAILABLE FROM SKIER'S CHOICE, INC. THE FUEL SYSTEM SHOULD BE SERVICED ONLY BY A SKIER'S CHOICE TRAINED CERTIFIED TECHNICIAN. DO NOT ATTEMPT TO SERVICE THE SYSTEM YOURSELF."



Docking Lights



The docking lights are designed to help you dock, load and unload your boat in low light or at night.

NOTE: Docking lights are not to be used as running lights at night. USCG regulations mandate that a boat under power after sunset must display a 360 degree white light and a red/green bow light.

Optional Automatic Fire Suppression System



The optional Automatic Fire Suppression System has a sensor in the engine compartment that is designed to detect a fire. Under normal conditions, the dash area warning light will glow green when the ignition is "ON". If the engine compartment sensor is activated by a fire, it will deploy the content of its fire extinguisher and the dash mounted warning light will turn red.



Typical V-Drive

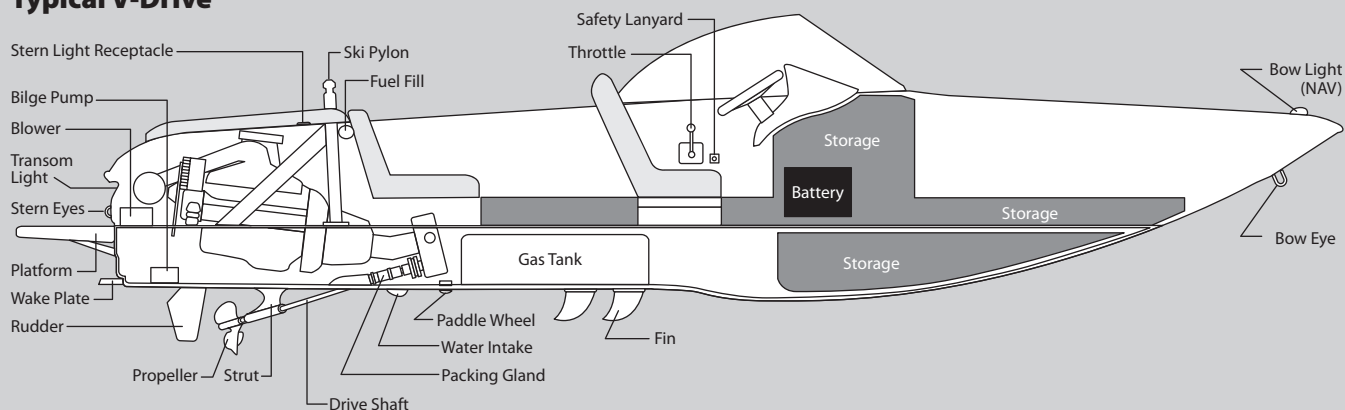

The illustration above denotes the areas which may need to be accessed or may require cleaning or maintenance. It is important to have basic understanding of the parts and their location on the boat. However, it is recommended that any service beyond routine maintenance be performed by an authorized Supra dealer.

Service & Maintenance

For your convenience, a maintenance schedule has been included in this manual. The items listed outline when to perform safety checks, lubrication and general service to your boat. Engine hours or elapsed time determine when service is necessary.

It is recommended that any replacement parts used during maintenance or for repair be supplied by an authorized Supra dealer.

NOTICE: You are responsible for keeping records of all maintenance on your boat. To maintain your new boat warranty, you may be required to prove that required maintenance was performed.



Maintenance Intervals @ Engine Hours

Maintenance To Perform	Weekly	1st 25	50	100	Yearly
Change Engine Oil		X	X	X	X
Replace Oil Filter		X	X	X	X
Clean Oil Filler Cap				X	
Check Transmission Fluid Level	X	X	X	X	X
Change Transmission Fluid					X
Check Water Strainer (if applicable)*	X	X	X	X	X
Clean Flame Arrestor		X		X	X
Clean Crankcase Ventilating System		X	X		X
Check Water Pump & Alternator Belt Tension	X	X			X
Check Fuel Lines & Connections for Leaks	X	X	X	X	X
Impeller Replacement				X	X
Clean Transmission Oil Strainer Screen					X
Lubricate Distributor Cam					X
Check Condition of Spark Plugs					X
Check Battery Electrolyte Level		X	X	X	X
Check All Electrical Connections		X			X
Check Cooling System Hoses for Leaks	X	X			X
Tighten Engine Mount Fasteners					X
Lubricate Throttle and Shift Linkage Pivot Points					X
Check for Loose, Damaged or Missing parts	X	X			X
Check Engine to Propeller Shaft Alignment		X		X	X
Check V-Drive Fluid Level**	X	X	X	X	X
Change V-Drive & Transmission Fluid**					X

* If engine overheats, visually check. If clogged, remove debris.

** Pertains to V-Drives only.

This inspection and maintenance schedule is recommended for average operating conditions in normal service. Under severe operating conditions or service, intervals should be shortened.

Cooling Systems

FRESH WATER COOLING SYSTEM

The standard cooling system for Supra boats is an open circulation cooling system with intake water. This is preferred for lakes and reservoirs with low salt content. If the engine is occasionally operated in salt water, the cooling system should be flushed with fresh water periodically and always before storage. If your boat is regularly operated in salt water, it should be equipped with the optional salt water package.

SALT WATER COOLING SYSTEM

The optional cooling system for use on salt water is a closed system with a solution of 50% antifreeze and 50% fresh water. The coolant is left in the closed system and replaced once a year.

Component Lubrication

Normal use of your Supra causes metal to metal movement at some parts in the boat. The driver's seat track should be lubricated with a water resistant chassis lubricant such as silicon grease.



Engine Oil and Filter



**V-Drive
Remote Oil
Filter**



**Oil Drain
Hose**

V-Drive engine remote oil filter is mounted in the engine compartment for convenience. The engine manufacturer recommends that you change the oil and oil filter after the first 10-20 hours use of your new boat. Thereafter, to maximize engine life, change oil and filter after every 50 hours of use (See Engine Manual).

Crankcase oil should be selected to deliver the highest performance for your operating conditions and climate. In general, engine oils with lower viscosity ratings are used when temperatures remain low or when better fuel economy is desired. Oils with higher viscosity ratings are used when temperatures remain higher and when higher performance is expected from the engine.

The Engine Manufacturer recommends Pennzoil 15W-40 Marine Motor Oil. If this is unavailable, use a 15W-40 motor oil with an A.P.I. classification rating of SL/SJ/CI4/Ch4/CG4 or equivalent.

REFER TO ENGINE MANUAL for more information.

Optional 345 Oil/Air Separator



The 2012 model Assault 345 engines are equipped with an oil/air separator so residual oil in the crankcase vapors is collected rather than being sucked back into the engine and burned. The oil/air separator must be drained periodically to make sure it does not overflow and spill oil on the engine. Drain the oil from the separator into a clean container and pour it back into the engine through the oil fill cap. Check for oil in the separator weekly under normal use. You may need to check more often if the boat is used primarily for wake surfing.

Oil Level Check

Engine oil level should be checked at regular intervals (such as every 5 engine hours). To obtain a true reading, when the engine is at operating temperature and turned off, check the oil level showing on the dipstick.

If the oil level is between the "FULL" and the "ADD" marks on the dipstick, simply replace the dipstick. When the oil level is at or below the "ADD" mark, add oil to return the level to the "FULL" mark.



Transmission Level Check

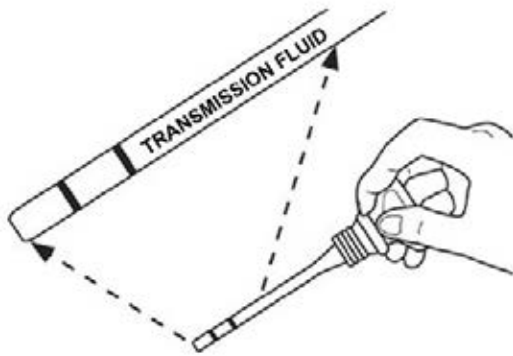

Transmission Fluid Check

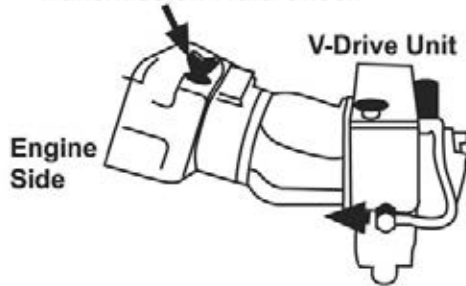

Use only automatic transmission fluid type "A" in transmissions with 1:1 drive train. Refer to Engine Owner's Manual.

Change Frequency

Change transmission fluid every year, using only Dextron-III Mercon automatic transmission fluid.

Maintaining Fluid Level

Transmission fluid level should be checked regularly and fluid added if necessary. Maintain fluid levels as follows:

- Boat must be at rest.
- Engine should be at operating temperature, but turned off while checking level.
- Remove transmission dipstick.
- Wipe fluid clean from dipstick and replace.
- Remove dipstick and note level indicated by the upper and lower marks.
- - If required, add fluid to bring the level to the upper mark.

V-Drive Fluid Check



The fluid level can be checked by using the oil level gauge, which is located on top of the V-Drive unit. This unit is located under the center cushion of the rear seat. Pull out the cushion to access the transmission.

Pull the oil level gauge to check the fluid level. If the level is low, add fluid to the correct mark on the dipstick. Use SAE 30 motor oil.

NOTE: Only a trained and qualified technician should perform the oil change on your V-drive unit.

Change Frequency

The oil should be changed in the V-drive unit after the first 100 hours of operation, then each year at the end of your boating season.

Maintaining Fluid Level

V-Drive unit fluid level should be checked regularly and fluid added if necessary. Maintain fluid levels as follows:

- Boat must be at rest.
- Engine should be at operating temperature, but turned off while checking level.
- Remove fluid dipstick.
- Wipe fluid clean from dipstick and replace.
- Remove dipstick and note level indicated by the upper and lower marks.
- If required, add fluid to bring the level to the upper mark.



Battery Cable Installation & Precautions

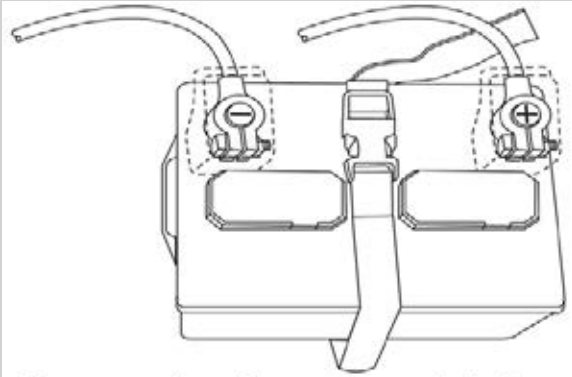

Use a good quality marine grade battery

Your battery is an important part of your boat. It provides all the power to start your boat and allows all of your electrical components (bilge pump, blower, stereo, etc.) to work even if the motor is not running.

Because of its important role, Supra recommends using a good quality "Marine Dual Purpose" battery. The "Dual Purpose" rating means that it can provide the cranking Amps needed to start your motor, yet it also has an Amp hour discharge rating so it can handle low electrical drawdown cycle.

Your Supra electrical system is a negative ground type. The negative battery cable is grounded to the engine block. The positive battery cable is connected to the starter solenoid.

Connect the positive (+) battery cable to the positive (+) post on the battery. Connect the negative (-) battery cable to the negative (-) post on the battery.

CAUTION

Failure to connect battery cables as outlined will damage the system and void the warranty.



WARNING

Sulfuric acid in the battery can cause serious burns. If spilled on skin or in eyes, flush with clean water immediately, then seek medical attention.



WARNING

Hydrogen and oxygen gases are produced during normal battery operation and charging. Sparks or flames near the battery vent openings can cause the mixture to ignite and explode.

Dripless Shaft Seal



Your Supra comes standard with a dripless shaft seal. If any seepage occurs, contact your dealer.



Fiberglass Care

Washing and waxing the boat hull and deck regularly will extend the life and beauty of your Supra. It is a good routine to rinse your boat with fresh water after each day's use.

It is recommended that the hull and deck be cleaned and waxed after every 25 hours of use. This will decrease water friction and lessen the potential for staining or spotting on the gelcoat surface.

When the original gelcoat shine cannot be restored by waxing, the shine may be restored by hand buffing with a commercial polishing compound. Be sure to apply a new coat of wax containing Carnauba over the area that has been polished.

IMPORTANT: Porcelain cleaning powders are too abrasive for use on gelcoat and may cause permanent discoloration if used. Household detergents containing ammonia or chlorine should not be used on gelcoat. Never use acetone or ketone solvents to clean your boat finish.

Washing Your Boat



The easiest way to preserve the beauty of your boat is to keep it clean by frequent washing. Wash the boat with luke warm or cold water. Wipe the boat down immediately after washing to avoid water spots. Avoid using hot water or washing your boat in direct sunlight. Avoid using strong soaps or chemical detergents. To avoid spotting, all cleaning agents should be thoroughly rinsed from the surface promptly and not allowed to dry on the finish.

Rub Rail Care



Use a sponge or other soft material to wash and wax the rub rail. To wax, use a commercial automotive bumper wax.

NOTICE: When tying up to a dock or another boat, always use cushioned fenders (dock bumpers) to protect your boat from hard surfaces.

Windshield Care



All Supra windshields are constructed of tempered safety glass to ensure passenger safety. The glass surfaces should be cleaned regularly to ensure that visibility is not obstructed.

Use a commercial glass cleaner to remove any spotting or stubborn stains that develop on the windshield. Never use abrasive cleaners on glass surfaces.

Upholstery Care



All upholstery items on your Supra are made of tough marine grade vinyl that is easily cleaned.

It is important to provide for the drying of all upholstery and carpet after each use of the boat. Open all storage compartments and slide all removable cushions out about an inch to allow air to circulate behind.

⚠ CAUTION

Strong detergents and cleaners may shorten the life of the vinyl. PLEASE SEE VINYL MANUFACTURER'S RECOMMENDED CARE GUIDE INCLUDED IN YOUR OWNER'S MANUAL PACKAGE.

FAILURE TO FOLLOW CARE GUIDE MAY VOID VINYL WARRANTY.

Drying Upholstery



It is important to provide for the drying of all upholstery and carpet after each use of the boat. Open all storage compartments and slide all removable cushions out about an inch to allow air to circulate behind.

Foreign Deposits

Tree sap, bird droppings, airborne chemicals, petroleum products and other foreign matter may damage the gelcoat surface if not removed promptly (See Washing Instructions).

Boat Hull Protection

If your Supra is to remain in the water for an extended period, the hull below the water line should be painted with a marine bottom paint. Boats left in the water for extended periods of time without bottom paint may experience blistering or discolorization. This type of damage is not covered by your boat's warranty.

Teakwood Care

If teakwood has been installed on your Supra, a small amount of maintenance will be required to retain the natural beauty. Teakwood should not be varnished. Instead, teak oil or mineral oil should be applied. Oil should be applied 3 to 4 times per year. If teak has been allowed to become gray and dry, sand with fine grit paper and reapply teak oil.

⚠ CAUTION

Damage caused by improper care, cleaning agents, conditioner oils, waxes, gasoline, etc., IS NOT covered under your boat's warranty. Use only the recommended vinyl cleaner as listed on the Vinyl Care Instruction Sheet.

Please refer to www.syntecind.com for more information regarding vinyl care.

Wet Slipping Boats

⚠ CAUTION

- In the event of large storms, boats in wet slips are more likely to be damaged.
- If you do not use the boat often, the battery can go dead from pumping out water.
- The boat may develop organic growth which can greatly reduce performance, attack and discolor the gelcoat.*
- The boat may develop osmotic blisters.*
- The boat may get a stain line which cannot be removed.*

*** Painting the area below the waterline of the boat with Interlux or Pettit products will reduce the likelihood of these last three.**



Winterization

When the boating and ski season comes to a close, it is important to have your boat professionally winterized.

If your boat is exposed to temperatures below 32 degrees F (0 degrees C), it is possible for water in the engine, ballast system, heater core, etc., to freeze. As this water freezes, it expands and can crack pumps, valves, heat exchangers, engine blocks, etc. This type of damage usually requires the replacement of the cracked item and can be very expensive to repair.

CAUTION

It is extremely important to follow the proper winterizing procedure. The engine must be correctly winterized for safe storage in your climate. This should be done by a professional. Your Supra dealer will know exactly what must be done to ensure the longest possible life for your boat.

In addition to having your boat professionally winterized, the following tasks should be done to protect your boat during storage:

1. Remove the drain plug from the boat.
2. Thoroughly clean the boat inside and out. Inspect the hull for any residue or algae growth and remove if required.
3. Clean the bilge area thoroughly and operate the bilge pump to remove any water from the bilge hose.
4. Remove all seat cushions and open all storage areas to air circulation in the boat interior. When thoroughly dry, replace cushions and close storage areas.
5. Top off fuel tank to prevent any condensation from accumulating in the fuel system. Use a commercially available fuel stabilizer to remove water and prevent gumming.
6. If the boat is stored on its trailer, ensure that the boat is properly positioned. If possible, lift the tongue so that the bow is slightly raised to promote drainage from the drain hole.
7. Install the canvas cover and secure the straps in accordance with cover instructions.

NOTE: During the winter months, water is a boat's worst enemy. Always store the boat when the interior is completely dry. Periodically check on the condition of the stored boat.

CAUTION

Damage due to improper winterization IS NOT covered under your boat's warranty.

CAUTION

E-10 fuels require fuel stabilizers that are specifically designed for E-10 fuels to help prevent moisture absorption, phase separation and gasoline stabilization.

Summerization

Before using the boat after it has been in dry storage requires some special treatment. Supra recommends having your boat professionally summerized, preferably by the same facility that prepped it for storage. They will be familiar with what items were done in the fall and what items need to be addressed in the spring.

In addition to having your boat professionally summerized, the following list of tasks should be done to ensure a successful start to your boating season.

- Check Trailer
- Tire Pressure
- Bearing Lube
- Lights

- Charge Battery
- Clean & Wax Gel Coat
- Clean Interior

- Check All Systems
- Blower
- Bilge Pump
- Navigation Lights
- Interior Lights

When launching the boat for the first time of the season, carefully watch all gauges to ensure that the boat is not overheating, the alternator is charging and the engine has proper oil pressure.



Temporary Hoisting

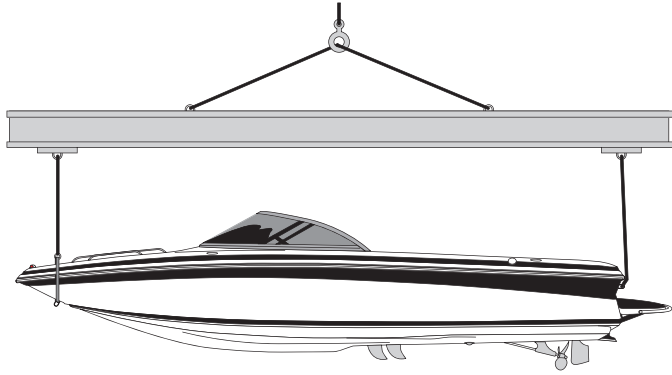

Correct Hoisting

If the boat ever needs to be hoisted, special attention should be given to the following recommendations:

- Hoist the boat using a horizontal lifting bar only.
- Never attempt to lift the boat by means of a cable sling from bow to stern lifting eyes.
- Hoist operator should slowly and smoothly lift the boat without jerking to avoid damage to the lifting eyes.

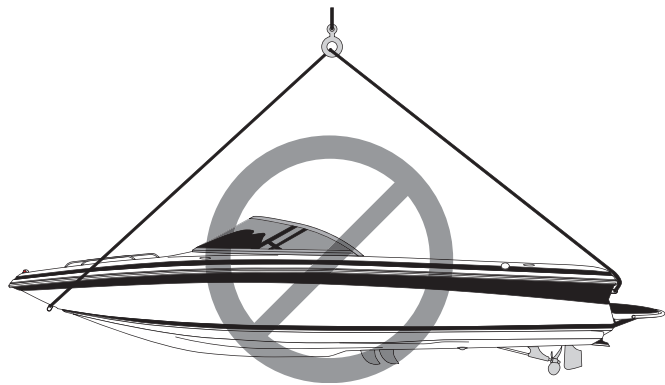

Incorrect Hoisting

⚠️ WARNING

DO NOT use the ski pylon to hoist the boat.

⚠️ CAUTION

Incorrect hoisting may invalidate the warranty on the boat.

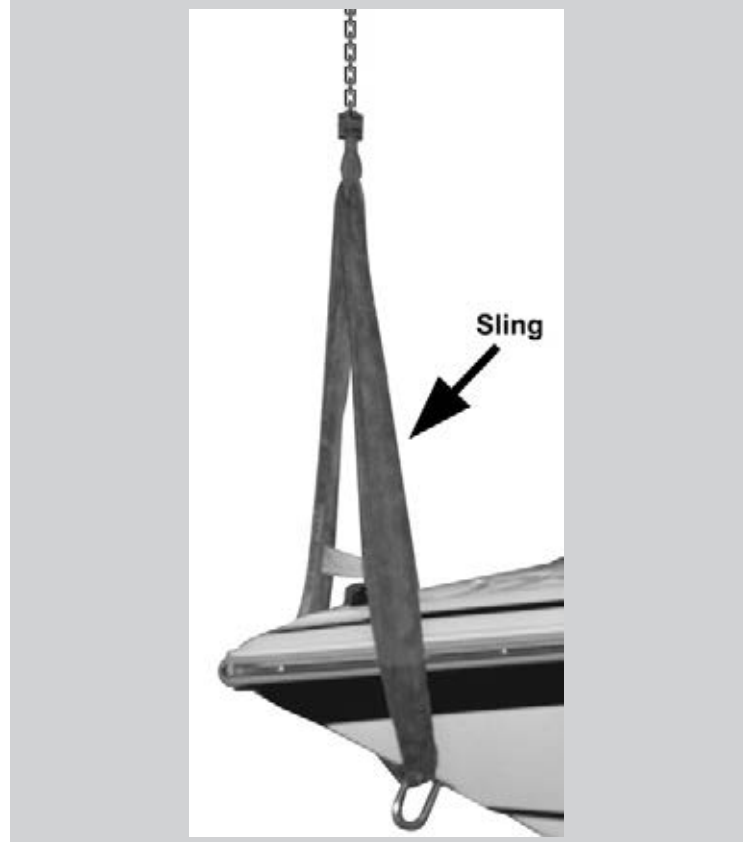

⚠️ WARNING

Use only a proper sized sling in the designated lifting rings to hoist the boat.



NOTE: For boat houses, we highly recommend the use of a lifting cradle. Cradle bunk design should mimic the bunk design of the trailer.



Identification Number



The hull identification number is located on the upper right hand side of the transom below the rub rail.

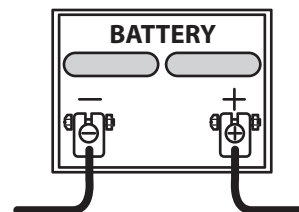

Battery Specifications

12 Volt Marine Type with Tapered Post Connectors

Engine Size: **Cold Crank**
350 ----- 400 Amps

Good quality Marine Dual Purpose battery recommended.

⚠ WARNING

Hydrogen and oxygen gases are produced during normal battery operation or charging. Sparks or flames can cause this mixture to ignite and explode if it comes near the vent openings. Sulfuric acid in the battery can cause serious burns if spilled on skin or in eyes. Flush with clear water immediately!

2012 Supra Engine Specs

Engine Model	Indmar Assault MPI 330	Indmar Assault MPI 345	Indmar Assault MPI 6.0L (L96)
Fuel Delivery:	Multi Port Injection	Multi Port Injection	Multi Port Injection
Induction System	Naturally Aspirated	Naturally Aspirated	Naturally Aspirated
Horsepower:	330 HP	345 HP	420 HP
Displacement:	350 CI (5.7L)	350 CI (5.7L)	364 CI (6.0L)
Bore (in):	4.00	4.00	4.0017
Stroke (in):	3.48	3.48	3.622
Compression Ratio:	9.4:1	9.4:1	9.67:1
Electrical System:	12 V Negative Ground	12 V Negative Ground	12 V Negative Ground
Ignition Type:	Electronic Distributor	Electronic Distributor	Electronic Distributorless
Thermostat:	162 Degrees F	162 Degrees F	162 Degrees F
Firing Order:	1-8-4-3-6-5-7-2	1-8-4-3-6-5-7-2	1-8-7-2-6-5-4-3
Oil Filter:	Pennzoil PZ-52	Pennzoil PZ-52	Pennzoil PZ-167
Oil Capacity (approx):	5.5 - Quarts	7.0 Quarts	6.0 Quarts
Oil Type:	Pennzoil 15W-40 Marine	Pennzoil 15W-40 Marine	Pennzoil 15W-40 Marine
Spark Plugs:	AC 41-993	AC 41-993	AC 41-110
Gap (in)	0.04	0.04	0.04
RPM Range @WOT	4,400-4,800 RPM	4,600 - 5,200 RPM	5,200 - 5,600 RPM
Fuel Type:	89 Octane - Unleaded	89 Octane - Unleaded	89 Octane - Unleaded

Transmission	Model	Capacity	Fluid Type
ZF Hurth In-Line	ZF 45C	1.7 qt (1.6L)	Dexron III ATF
ZF Hurth In-Line	ZF 45A	2.12 qt (2L)	15W40 Motor Oil
ZF Hurth In-Line	ZF 63A	4.2 qt (4L)	15W40 Motor Oil
Walters V-Drive	RV-26D-71V	.5 qt (.5L)	15W40 Motor Oil



2012 Supra Electrical Replacements				
	Breakers, Fuses, & Relays	Type	Size (amps)	Location
Fuse Block	ECM	ATM	20	On Engine at Transmission
	Fuel Pump	ATM	20	
	Fuel Pump 2	ATM	20	
	Fuel Pump Relay	Relay	NA	
	Helm	ATM	20	
	Main	ATM	40	
	Power Relay	Relay	NA	
	PTR	ATM	20	
	Starter	ATM	20	
	Starter Relay	Relay	NA	
	VSW	ATM	5	
	Battery Storage	Main Buss Bar	ANL	
Amp Harness (4/5 Channel)		MAX	40	
Amp Harness (2 Channel)		MAX	80	
Amp Fuses (back of amp) 2 CH		ATO	25 x 2	
Amp Fuses (back of amp) 4 CH		ATO	20	
Amp Fuses (back of amp) 5 CH		ATO	40 x 2	
Main Dash Breaker		Breaker	50	
Breaker Panel	Ignition	Breaker	10	Under Dash
	Bilge Pump	Breaker	3	
	Blower	Breaker	4	
	GPS / Ballast	Breaker	3	
	Nav/Anc. Lights	Breaker	5	
	Courtesy Lights	Breaker	10	
	Acc / Docking Lights	Breaker	10	
	Horn	Breaker	4	
	Stereo	Breaker	10	
	Amplifier 2	Breaker	15	
	12V Receptacle - Port	Breaker	15	
	12V Receptacle - Stbd	Breaker	15	
	Acc / Underwater Lights	Breaker	3	
	Driver's Seat	Breaker	5	
	Acc / Heater	Breaker	15	
	Acc / Tower Lights	Breaker	3	

Bulbs	Type	Size
Bow Light	3175	12V8W
Courtesy Light	Sealed	(See Dealer)
Docking Light	MR16	50W 24 Degree
Gauges	161	12V
Pole Light	906	12V
Tower Light	906	12V

Fuse Panel - Under Dash



Fuse Panel - Battery Connection



Fuse Panel - Back of Engine



Main Dash Power-Circuit Breaker - Battery Connection



The power to the dash circuit is protected by a circuit breaker that is located in the observer seat storage area near the battery.

To turn off the power to the dash, manually press the red button and the circuit breaker reset lever will flip down and the power to the dash circuit will be shut off. To reset the breaker, push the reset lever back up.

If all of the dash switches fail to work, reset the main dash power-circuit breaker.

Main Ballast Power-Circuit Breaker - Battery Connection



The power to the ballast pump circuit is protected by a circuit breaker that is located in the port side of the engine compartment.

To turn off the power to the ballast pump, manually press the red button and the circuit breaker reset lever will flip down and the power to the ballast circuit will be shut off. To reset the breaker, push the reset lever back up.





Trailer & Towing

The trailer supplied with your Supra was designed especially for the boat with your convenience in mind. Please be sure that you have an appropriate tow vehicle before attempting to trailer your boat. Your vehicle must be capable of towing 5,000 lbs. and must be fitted with no less than a Class III (5,000 lb. max.) trailer hitch.

CAUTION

Read the trailer towing section of your vehicle owner's manual before towing your trailer.

All Supra trailers require a 2" ball and a five (5) pin marine grade trailer wiring connector. The standard height from the ground to the top of the hitch ball should be about 20 inches. With the trailer attached to the tow vehicle, the trailer should stand approximately level.

Trailer Plug Wire Schematic

White:	Ground
Green:	Right Turn / Brake
Yellow:	Left Turn / Brake
Brown:	Running Lights
Blue:	Reverse Lights

NOTE: Supra trailers feature disk brakes. The 5th wire (blue) on the wire connector needs to be connected to your vehicle's reverse lights to be operative. This wire (blue) provides power to a solenoid which deactivates the brakes while in reverse. You may still tow your trailer without the blue wire connected, however, you may experience difficulty backing the trailer.

Prolong Trailer Life

The following guidelines will prolong the life of the boat and trailer:

1. Always secure the boat to the trailer with tie-downs. Do not place straps around fenders or lights.
2. Always verify that the winch hook is securely in the bow eye, the strap is tight and the winch handle locked in place before trailering.
3. Check the recommended pressure displayed on the side of the tires and assure that it is maintained. Under-inflated tires could cause trailer sway and excessive tire wear.
4. Before use, please read all information supplied with the trailer by the manufacturer (Bearing Buddy, Boat Buddy and hydraulic brake actuator). Check wheel bearing grease.
5. Before operating Boat Buddy, check trigger setting and latch pin location. After loading, check latch pin and confirm that it is properly seated in the eye hook before pulling trailer out of water. Wash Boat Buddy moving parts with high pressure water.
6. Check wheel bearing lube.
7. See Trailer Owner's Manual for Maintenance Schedule.

CAUTION

Inadvertent release of latch pin could result in injury.

Connecting the Trailer



When connecting the trailer to your tow vehicle, use the following procedure:

1. Raise the tongue with the trailer jack. Position the trailer tongue directly over the 2" ball, and lower the jack until the tongue goes all the way down over the ball.
2. Press down on the latch until it locks on the ball with a "click."

NOTICE: If your hitch ball has an excessive flat spot on top, the latch may not engage properly. If the latch does not catch, check with your dealer or hitch installer before trailering.

3. Insert the locking pin into the tongue. Lock pin hole is on the side of the tongue.
4. When all weight is off the trailer jack, pull the jack lock pin and rotate the jack to the horizontal position and re-lock the pin.
5. Attach the safety cables to the tow vehicle hitch. Cross the cables and wrap them around each other once or possibly twice allowing just enough slack to permit tight turns of the vehicle and trailer.
6. Plug the trailer lights connector to the vehicle harness.
7. Clip the brake lockout cable to the vehicle hitch.

Trailer Alignment



When pulling the boat onto the trailer, be sure that it is centered on the trailer.



The distance between the boat and the wheel runner board should be equal on both sides.





Unloading Procedure

To unload the boat, use the following procedure as a guide:

1. Make sure that all drain plugs are securely in place.
2. Unplug light cord before backing into the water.
3. With Bow Eye Hook fastened, retract Boat Buddy latch pin by pulling trigger into "safety" position. (If latch pin is bound, tighten winch to relieve pressure, then pull trigger into "safety" position).
4. With Bow Eye Hook fastened, back the trailer until the water level is approximately 1 inch below the top of the trailer fenders. **NOTICE:** Ramp slopes vary, so actual level of water on trailer may be different. **(NOTE: Caution on this page!).**
5. Follow the cold start procedure recommended in this manual.
6. After starting the engine, remove Bow Eye Hook.
7. With engine idling, center steering wheel, engage transmission and slowly pull throttle into reverse. Ease back on the throttle lever until the boat starts to move.

NOTE: DO NOT attempt to use excessive power to free the boat from dry carpet runners. Power off of the trailer only when the boat has floated free.

CAUTION

If the trailer is not submerged to the correct depth, the bow of the boat could drop when powering off incorrectly, possibly damaging the boat.

WARNING

Roll driver's side window of tow vehicle down prior to backing down ramp. Should the vehicle slip into the water, the driver can escape through open window.

NOTE: Because your Supra is a direct drive inboard, when backing up, the stern will have a tendency to drift left or right depending on propeller rotation.

Loading Procedure

To load the boat on the trailer, position the trailer in the water with approximately 1 inch of the top of the fender showing.

1. Set the Boat Buddy for loading by pulling trigger or latch mechanism into "set" position.
2. Idle/coast the boat onto the trailer using as little power as possible, while keeping it centered between the guide poles.
3. Power slowly forward until the bow eye solidly contacts the Boat Buddy and the latch is triggered.
4. Winch hook must be attached to bow eye and tightened before trailering.

DO NOT Power onto the trailer during rough conditions! Once correctly positioned on the trailer, switch off ignition.

DO NOT OVER-POWER onto trailer or damage may occur to the boat and/or the trailer!

CAUTION

The trailer must be positioned for the correct water depth for loading or you may damage the boat. Varying ramp angles require different procedures. In general, the steeper the ramp, the more shallow the trailer should be positioned in the water. Your local dealer can help you understand this, should you require additional assistance.



Trailer Basics

See trailer owner's manual for additional product information, safety information and warnings.

Tandem Axle



Some models come standard with a tandem axle trailer and with some it is an option.

Second Axle Disc Brakes



The second axle disc brakes give the trailer more stopping power.

Surge Brakes Fluid Reservoir

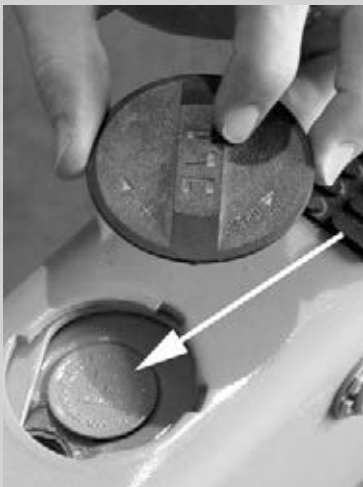

To check brake fluid, twist black cap and remove. Pry rubber plug out of reservoir. Follow instructions printed on plug. Use DOT 3 Brake Fluid.

Swing-Away Tongue

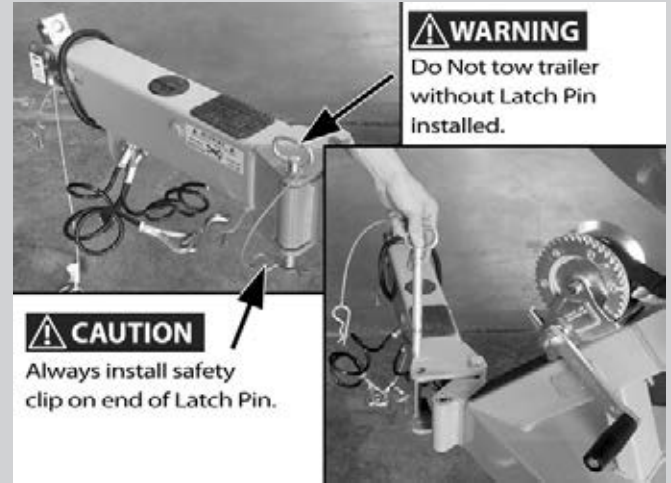

Optional Stainless Steel Swing-Away Tongue available.



With the swing tongue, you can shorten the trailer length for storage by pulling the pin and swinging the tongue away to the side.

WARNING

DO NOT tow trailer without latch pin installed.

CAUTION

Always install safety clip on end of latch pin.

Vault Bearings



Your trailer features Vault bearings. See trailer owner's manual for more information.



LED Package

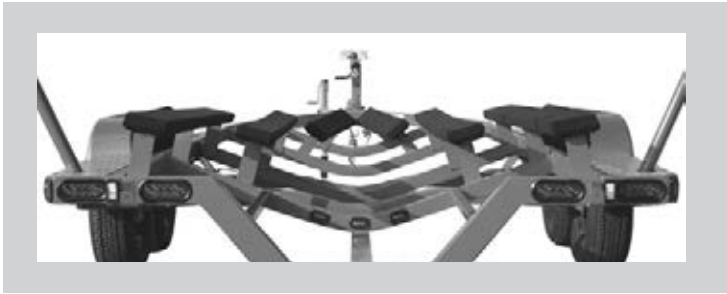

The LED lighting package replaces the traditional trailer lights with LED lights. The LED lights are brighter than the traditional lights.

NOTE: Vehicles with trailer light monitors may not function properly with LED lights due to the low resistance of the LED lights. Aftermarket resistor packages are available, which allow the monitors to work properly.

Aluminum Step Plate



The optional aluminum step plate gives the trailer a durable, long-lasting nonskid surface on the trailer steps.

Laser Cut Steps



The optional laser cut steps are backlit, so they illuminate when the trailer's running lights are illuminated.

Aluminum Wheels



The optional aluminum wheels are a trailer grade wheel. They are a great way to dress up your trailer.

World's Edition Wheels



The Gravity Games Edition 24SSV and World's Edition comes with custom wheels.

NOTE: See trailer packet for more information regarding tire size and rating.

Spare Tire Bracket

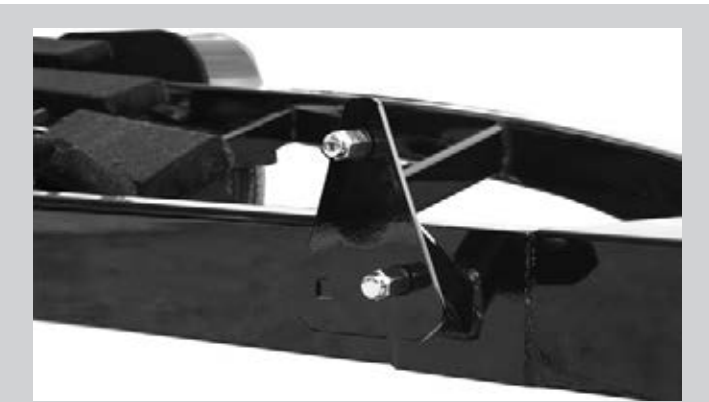

The optional spare tire bracket allows you to conveniently carry a spare tire.



Optional Boat Buddy



This feature makes loading your boat on the trailer much easier.

Loading

Place the trigger in the "SET" position. When the bow eye contacts the Boat Buddy, the pin will latch, securing the boat.



Unloading

To unload the boat, pull back on the trigger and locate it in the "SAFETY" position.



Taking care of our product after it becomes yours has always been “standard practice” at Skier’s Choice, Inc., the proud manufacturer of the Supra water sport boats. As evidence of our continuing commitment, each Supra boat is covered by the manufacturers’ warranty.

Year 1 – Supra Limited Warranty for components

Lifetime – Supra Limited Warranty for fiberglass structure

Engine - Indmar Products Limited Warranty for the engine

Trailer - Boatmate Trailers Limited Warranty

For complete information, please refer to the individual policies. Exclusions and limitations apply. The Indmar program is described in separate booklets.

TERMS OF SUPRA LIMITED WARRANTY

During the applicable Warranty Period (as defined below), Skier’s Choice, Inc. (“Skier’s Choice” or the “Company”) warrants to the original retail purchaser (the “First Owner”) that the components and parts manufactured by Skier’s Choice (the “Covered Components”) of each new Supra boat are free from any defects in material and workmanship, under normal use and when operated and maintained according to boat’s instructions (“Normal Use and Operation”).

- This Limited Warranty applies to all Covered Components other than the deck, hull, floor and stringers for a period of one year (the “One-Year Warranty Period”) from the original date of purchase by the First Owner (the “Original Purchase Date”). Exclusions do apply.
- This Limited Warranty applies to the deck, hull, floor (excluding carpet) and stringers for the lifetime of the boat (the “Lifetime Warranty Period”). Exclusions do apply.
- This Limited Warranty applies to the gel coat for a period of one year (the “One- Year Warranty Period”) from the original date of purchase by the First Owner (the “Original Purchase Date”). Exclusions do apply.

This Supra Limited Warranty may be transferred to a second owner. The remaining duration of the Supra Limited Warranty from the first owner’s original purchase date is transferable. A nominal warranty transfer fee and a dealer inspection are required. Boats that are damaged or have been abused may not be eligible for the warranty transfer. Inspection and fee need to be completed within 14 days of the sale to a subsequent owner or the boat will not be eligible for the warranty to transfer.

Subject to the terms of this Limited Warranty, Skier’s Choice will repair or replace, at its sole option, any Covered Component which is returned during the applicable Warranty Period to the Skier’s Choice factory or to any other Supra authorized repair facility (an “Authorized Supra Facility”), provided that:

- Only the Covered Components that are declared defective upon examination by Skier’s Choice will be repaired or replaced under this Limited Warranty;
- Transportation of the boat, parts or components to and from the Skier’s Choice factory or the Authorized Supra Facility must be pre-paid by the owner;
- Notice of any claim under this Limited Warranty must be provided to Skier’s Choice by the Authorized Supra Facility no later than sixty (60) days after the owner becomes aware of the defect.
- The boat was purchased at a dealership authorized by Skier’s Choice, Inc. to distribute the product in the country in which the sale occurred.

Notification of a claim or defect must be properly made directly to an Authorized Supra Facility, who subsequently must submit the claim information to Skier’s Choice at 1717 Henry G. Lane Street, Maryville, Tennessee 37801. Information needed for processing a claim includes (1) Name and address of the owner; (2) Serial number of the boat; (3) Original retail purchase date; (4) Detailed explanation of the defect; and (5) Estimated repair cost.

Note: Warranty repair or replacement cannot be made until this information is approved by Skier’s Choice.

In case of defect of a Covered Component, Skier’s Choice will use its reasonable best efforts to repair or replace the Covered Component within ninety (90) days of receipt thereof at its factory or an Authorized Supra Facility. Any warranty on replaced or repaired components pursuant to this Limited Warranty shall remain in effect only for the remainder of the original Warranty Period. The repair or replacement of Covered Components will be made by Skier’s Choice without charge to the owner for parts or labor. The replacement or repair of



the defective part or component as stated in this Limited Warranty shall be the sole remedy of the owner and the sole liability of the Company under this Warranty and any implied warranties.

There are no express or implied warranties on the parts and components manufactured or sold by Skier's Choice except as set forth in this Limited Warranty.

EXCLUSIONS

Claims or assertions relating to the following are specifically excluded from coverage under this Limited Warranty and Skier's Choice disclaims any liability or obligation with respect to the following:

1. Defects in or damage caused by or relating to the engine or any part thereof. (Note: The engine may be covered by warranty of the engine manufacturer. Please see engine manufacturer warranty for details.)
2. Defects in or damage caused by or relating to the trailer or any part thereof. (Note: The trailer may be covered by warranty of the trailer manufacturer. Please see trailer manufacturer warranty for details.)
3. Covered Components of a boat that has been sold or transferred by the First Owner and the warranty transfer was not completed.
4. Damage caused by, related to, or resulting from failure of components or parts which are not manufactured by Skier's Choice, including but not limited to bilge pump failure.
5. The Limited Lifetime Warranty on the deck, hull, floor (excluding carpet) and stringers does not include hardware or other components fastened or adhered to the hull, deck, floor or stringers.
6. Normal maintenance and upkeep relating to the boat or any part thereof, including but not limited to, alignment, adjustments, connectors, tune-ups and wear items, such as, shaft packing, belts, hoses, filters, seals, gaskets, strut bushing, etc.
7. Damage to or malfunction of a boat, or any component thereof, resulting from owner use, lack of maintenance, improper maintenance, impact, misuse, negligence, collision, delay in repair, improper hoisting or cradling of the boat.
8. Any and all consequential damages including, but not limited to, costs incurred for haul-out, launching, towing and storage charges, telephone or rental charges of any type, inconveniences, loss of use, or loss of time or income.
9. Equipment installed by anyone other than authorized factory personnel at the Company's production facility. Equipment replaced at an Authorized Supra Facility pursuant to this warranty agreement remains under warranty until the expiration of the Limited Warranty period.
10. Any boat which is: (a) used for rental or other commercial, military or industrial purposes; (b) used in boat racing, demonstrations, ski school, or similar events; (c) altered, modified, repaired or replaced so as to increase the cubic inch capacity or horsepower output of the engine and boat as originally manufactured; (d) not properly stored or maintained.
11. Any boat which is: (a) repossession from a retail customer; (b) purchased at auction (bank auction, online auction, auction house, etc.); (c) purchased from a salvage yard; (d) purchased from an insurance company that obtained the product as a result of an insurance claim.
12. Speeds, fuel consumption and other performance characteristics because they are estimated and may vary.
13. Damage to or defects in paints, varnishes, gelcoat surfaces and colors, finish distortions, chrome plated or anodized finishes, floor covers and any other surface coatings.
14. Gelcoat discoloration, blisters or bubbles, including, but not limited, to those which may result from a boat being left in the water for long periods of time.
15. Upholstery cracks, mildew, stains or tears resulting from owner use, lack of maintenance, improper maintenance, impact, misuse, negligence, delay in repair, use of improper cleaners or conditioners.
16. Gelcoat limited warranty is not transferable to a second owner and its duration is limited to one (1) year from the original purchase date.
17. Any boat purchased from a dealer in another country, where the primary use of the boat will require the boat to cross an international border, except to the extent otherwise expressly provided in a separate written agreement between the First Owner and Skier's Choice.
18. Skier's Choice reserves the right to improve its products through changes in design or material without being obligated to incorporate such changes in products of prior manufacture.

OTHER LIMITATIONS

1. THIS LIMITED WARRANTY LIMITS THE DURATION OF ANY IMPLIED WARRANTY OF MERCHANTABILITY OR IMPLIED WARRANTY OF FITNESS FOR A PARTICULAR PURPOSE TO THE PERIODS SPECIFIED HEREIN. Some states do not allow limitations on how long an Implied Warranty lasts, so this limitation may not apply to you.
2. THE REMEDIES OF REPAIR OR REPLACEMENT AT THE OPTION OF SKIER'S CHOICE, AS SET FORTH HEREIN, ARE THE ONLY REMEDIES AVAILABLE UNDER THIS WARRANTY. SKIER'S CHOICE DISCLAIMS ANY OBLIGATION OR LIABILITY FOR COSTS OR CHARGES DERIVED FROM INCONVENIENCE OF LOSS OF USE, COMMERCIAL OR MONETARY LOSS DUE TO LOSS OF TIME, INCONVENIENCE, OR ANY



OTHER CONSEQUENTIAL, SPECIAL OR INCIDENTAL DAMAGES. Some states do not allow the exclusion or limitation of incidental or consequential damages, so the above limitations or exclusions may not apply to you.

3. THIS WARRANTY IS IN PLACE OF ANY OTHER EXPRESS WARRANTIES.
4. THIS WARRANTY APPLIES TO THE FIRST OWNER. Unless the warranty was properly transferred to a second owner.
5. THIS WARRANTY GIVES YOU SPECIFIC LEGAL RIGHTS, AND YOU MAY ALSO HAVE OTHER RIGHTS WHICH VARY FROM STATE TO STATE.
6. THIS WARRANTY IS EXPRESSLY IN LIEU OF ANY CONTRACTUAL LIABILITIES, INCLUDING PRODUCT LIABILITIES.
7. THE DEALER IS NOT THE AGENT OF SKIER'S CHOICE AND SKIER'S CHOICE DOES NOT AUTHORIZE THE DEALER, OR ANY OTHER PERSON, TO ASSUME ON BEHALF OF SKIER'S CHOICE ANY LIABILITY OR EXPENSE INCURRED IN THE COURSE OF REPAIRING ITS PRODUCTS

Owner's Responsibility

1. Before operating your Supra, it is necessary to read and fully understand this Owner's Manual and all other information delivered with the boat.
2. It is the owner's responsibility to take the boat to an authorized Supra dealer to obtain warranty service.
3. It is the owner's responsibility to properly operate and maintain the boat in accordance with this manual and all other information delivered with the boat.
4. The owner should keep maintenance records, should it be necessary to show that required maintenance has been performed on the boat.

Dealer's Responsibility

1. The Dealer should provide the buyer with an adequate orientation in the general operation of the boat and review all systems and accessories included with the boat.
2. The Dealer should deliver a complete owner's manual packet with the boat consisting of Owner's Manual, Registration, Engine Manual, Stereo Manual, Supra Warranty and all warranties for separately warranted items aboard the boat.
3. The Dealer should review all warranty information with the buyer and assist in filling out warranty cards if necessary.
4. The Dealer should ensure that any information or obligation from either Skier's Choice, Inc. or from the dealership is clearly understood by the buyer.
5. The Dealer should instruct the buyer in obtaining local service and out-of-area service for a Supra boat.

Customer Assistance

The staff at Skier's Choice, Inc. is concerned with your complete satisfaction. This includes the prompt resolution of any problems that may arise during the warranty period. Normally, problems encountered may be efficiently and effectively resolved by your Supra Dealer. However, if a problem cannot be handled by the Dealer or if a solution is not satisfactory to you as an Owner, please follow these steps to get the matter resolved:

STEP ONE

Discuss the problem with a member of your Supra Dealer's management staff. It is most likely that the problem will be resolved at this level.

STEP TWO

If the Dealer management does not resolve the problem to your satisfaction, please have the problem and all action taken, documented by the Dealer, then contact the factory Customer Service Representative at Skier's Choice, Inc.:

Skier's Choice, Inc.
1717 Henry G. Lane Street
Maryville, TN 37801
Tel: (865) 983-9924 Fax: (865) 983-9950

Describe the original problem in detail to the Customer Service Representative. Be prepared to furnish appropriate documentation and the reasons why service by the Dealer was unsatisfactory. If further action is required to resolve the problem, the Customer Service Representative will dictate the appropriate action.

STEP THREE

Finally, if after following these steps and providing documentation and after obtaining necessary authorization from the Customer Service Representative to take additional action, the problem is still not resolved to your satisfaction, the President of Skier's Choice, Inc. will personally review the problem and make a determination concerning final resolution.



Watersports Safety Code

Before you get in the water: Skiing or riding instruction is recommended before use. Instruction will teach general safety guidelines and proper skiing or riding techniques, which may reduce your risk of injury. For more information on skiing or riding schools, contact your dealer, Association, or local ski club.

- Know the federal, state and local laws that apply to your area.
- If you are not familiar with a waterway, ask someone who is, to tell you about any hidden dangers or things to avoid
- Whether you plan to be in a watercraft, or skiing/riding behind one it is important you are wearing a properly fitted life jacket (PFD) approved by your country's agency, USCG Type III, ISO, etc.
- Inspect all equipment prior to each use, check bindings, fins, tube, attachment, tow rope and flotation device. Do not use if damaged.

Watercraft Safety: A knowledgeable and responsible driver is the most important safety device on any watercraft.

- Never operate a watercraft, ski or ride under the influence of alcohol or drugs.
- Only use water ballast and people for additional weight.
- Never exceed the passenger or weight limitations of the watercraft.
- Never allow passengers to hang outside the watercraft or towed device or sit on the gunwales or anywhere outside of the normal seating area.
- Never allow water to overflow the bow or gunwales of the watercraft.
- Uneven weight distribution or additional weight may; affect the handling of the watercraft.

Carbon Monoxide: The exhaust from the engine on a watercraft contains Carbon Monoxide (CO) which is a colorless, odorless and poisonous gas. Excessive exposure to CO can cause severe injury or death.

Follow this advice to avoid injury:

- Never "Platform Drag" by holding onto the boarding platform or be dragged directly behind the watercraft. This is where CO will be.
- Do not sit on the watercraft transom or boarding platform while the engine is running.
- Make sure the engine is properly tuned and running well. An improperly tuned engine produces excessive exhaust and CO.
- If you smell engine exhaust, do not stay in that position.
- Go to the United States Coast Guard's website: www.uscgboating.org for more information on how to help protect yourself and others from the dangers of CO.

Tow Ropes: Tow ropes come in different lengths and strengths for different activities. Make sure any rope you are using is suited for skiing or riding and that it is in good condition.

- Never use a rope that is frayed, knotted, unraveling or discolored from use or being left in the sun. If a rope breaks while in use, it can recoil at the skier/riding being towed or into the watercraft where it might strike passengers. Replace tow ropes with any sign of damage.
- Never use a tow rope with elastic or bungee material to pull skiers or riders.
- Rope should be attached to the watercraft in an approved fashion with hardware designed for towing. Refer to your watercraft manual for instructions on proper tow rope attachment.
- Always keep people and tow ropes away from the propeller, even when idling.
- If a tow rope should become entangled in a propeller, shut off the engine, remove the key and put it in your pocket before retrieving the rope.

Preparing to ski or ride: Always have a person other than the driver as an observer to look out for the skier/riding.

- BE sure the driver is aware of the experience and ability level of the skier/riding.
- The driver, observer and skier/riding need to agree on hand signals before skiing or riding. Signals should include READY, STOP, SPEED UP, and SLOW DOWN.
- Start the engine only after making sure that no one in the water is near the propeller.
- **Turn the engine off when people are getting into or out of the watercraft, or in the water near the watercraft.**
- Always make sure the tow rope is not wrapped around anyone's hands, arms, legs, or other parts of the body.
- Start the watercraft and move slowly to remove slack until the tow rope is tight.
- When the skier/riding signals READY and there is no traffic ahead, take off in a straight line. Adjust the speed according to the signals given by the skier/riding.



Skiing or Riding: The watercraft and skier/rider should always maintain a sufficient distance from obstacles so a skier/rider falling or coasting and/or watercraft will not encounter any obstacle.

- Do not use in shallow water or near shore, docks, pilings, swimmers, other watercraft, or any other obstacles.
- Use only on the water.
- Never attempt land or dock starts. This will increase your risk of injury or death.
- Always wear a properly fitted U.S. Coast Guard Type III (PFD) or ISO approved Life Jacket.
- The faster you ski or ride, the greater your risk of injury.
- Never make sharp turns that may cause a slingshot effect on the skier/rider's speed.
- Skier/Rider should be towed at an appropriate speed for their ability level.

Fallen skier or rider: Falling and injuries are common in skiing or riding.

- Circle a fallen skier/rider slowly to return the tow rope handle or pick up the fallen skier/rider.
- Put the watercraft in neutral when near a fallen skier/rider.
- Always keep the fallen skier/rider in view and on the driver's side of the watercraft.
- Display a red or orange skier-down flag to alert other vessels that a skier/rider is down.

The Warnings and practices in the Watersports Safety Code represent common risks encountered by users. The code does not cover all instances of risk or danger. Please use common sense and good judgement.

Watersports Responsibility Code

Be aware that there are elements of risk in boating, skiing, and riding that common sense and personal awareness can help reduce. Know your ability level and stay within it.

To increase your enjoyment of the sport follow the "Watersports Responsibility Code".

It is your responsibility to:

- Familiarize yourself with all applicable laws, the risks inherent in the sport, and the proper use of equipment.
- Know the waterways where you will be skiing or riding. Do not ski or ride in shallow water, near shore, docks, pilings, swimmers, or other watercraft.
- Always have a person other than the boat driver as an observer and agree on hand signals before starting.
- Always wear a U.S. Coast Guard type III (PFD) vest.
- Read your owner's manual and inspect your equipment prior to use.
- Ski or ride within your limits. Always ski or ride in control and at speeds appropriate for you ability.
- Always turn ignition off when anyone is near watercraft power drive unit.
- Carbon Monoxide (CO) poisoning from engine exhaust may cause injury or death. Never "Platform Drag" or touch a swim platform while the engine is running.
- Do not operate watercraft, ski or ride under the influence of alcohol or drugs.
- Water Sports Industry Association



A	
Accessory Power Switch	43
Air Inflator—(models with steps)	62
B	
Ballast System - Gravity (Optional)	46
Battery & Cable Installation	71
Battery Box	59
Battery - (Dual Battery Optional Hookup)	59
Battery Specifications	77
Bilge Pump Switch	43
Bimini Top (Optional)	58
Blower Switch	43, 44
Boating Rules	15-17
Boating Safety	5-9
Boat Specifications	19-21
Bow Eye	54
Bow Light	53
Break-In Period	23
C	
Canvas Cover - Mooring	61
CD Changer (Optional)	63
Circuit Breaker Panels	45
Coast Guard Regulations	24
Cockpit Cover (Optional)	61
Component Lubrication	68
Cooler	60
Cooling Systems	63, 68
Courtesy Lights	43, 53
Customer Assistance	87
D	
Daily Check List	4
DC Outlet	47
Dealer's Responsibilities	87
Depth Temperature Screen	30
Double-Up Seating	56
Drain Plug - (Center V-Drive)	27
Driver's Seat	50
E	
Engine Data	77
Engine Hours	39
Engine Warm-Up	26
Electrical Replacements (Bulbs & Fuses)	78
Emergency Procedures	11-13
F	
Fiberglass Care	73
Filling Fuel Tank	28, 64
Fire Extinguisher	51
Foreign Material Deposits - Upholstery	74
Fresh Water Flush	63
Fuel	28
Fuel Cap	28, 49, 64
Fuel Filter	65
Fuel Gauge	31
Fuel Information	28, 64
Fuel Precautions	28, 64
Fuel Tank Pump	65
Fuel Vent	64
Fire Suppression System	66

G	
Glove Box	57
H	
Heater	58
Heater Switch	43
Hoisting	76
Horn	44
Hull Identification Number	77
Hull Protection	74
I	
Ignition	44
Ignition Key	49
Information Center	32
Introduction	3
Instrument Panel & Controls	29
J	
K	
L	
Lifting Rings	54
Lights—Courtesy	53
Lights—Docking	43, 66
M	
Maintenance Chart	68
Maximum Capacities	24
Mirror	49
Mooring Cover (Optional)	61
N	
Navigation Lights	43
Navigation Lights - Tower	53
Neutral Lock Out (Transmission)	26
O	
Oil Dipstick	69
Oil & Filter	69
Oil Level Check	69
Oil Pressure Display	32
Operating Information	23
P	
Pole Light	53
Pole Light Receptacle	53
Propeller	56
Propeller Precaution	56
R	
Tower	52
Rear Drain Plug	27
Rub Rail Care	73

(Continued Next Page)

Index (continued)

S

Safety Lanyard/Engine Shut-Off Switch	45
Safety Equipment	6
Satellite Radio (Optional)	62
Seat Adjustment	50
Service & Maintenance	67
Shaft Seal (Dripless)	71
Ski Locker	55
Ski Platform	54
Ski Platform Detachable Brackets	55
Ski Pylon	51
Slalom Course Speeds	29
Speedometer	30
Speed Calibration	36-40
Speedometer Paddle Wheel	30
Starting & Operation	23, 25
Stereo	42
Stereo Amp (Optional)	62
Stereo Remote - Transom Mount (Optional)	42, 60
Stereo Switch	43
Stern Light	53
Subwoofer (Optional)	62
Summerization	75
Sundeck	56
Sundeck V-Drive Stepway	55

T

Tachometer	30
Teakwood Care	74
Temperature Display	32
Throttle Lever	26
Tonneau Cover (Optional)	61
Tower	52
Tower Navigation Light	53
Tower - Progressive	52
Tower Speakers (Optional)	60
Tilt Steering	45
Trailer	45, 79
Aluminum Step Plate	83
Aluminum Wheels	83
Boat Buddy	84
Surge Brakes	82
Vault Bearings	82
World's Edition Wheels	83
Swing Tongue (Optional)	82
Boat Connecting	80
Laser Cut Steps	83
LED Package	83
Loading Procedure	81
Second Axle Disc Brakes	82
Spare Tire Bracket	83
Tandem Axle	82
Trailer Alignment	80
Unloading Procedure	81
Transmission	70
Fluid Check	70
Fluid Specifications	70
Lockout	26
Trim Gauge	31
Trim Switch	57
Triple-Up Seating	56

U

Upholstery Care	74
-----------------	----

V

V-Drive	
Engine Compartment	50
Fluid Check	70
Fuel Tank	65
Remote Oil Filter	69
Warning Light	45
VISION Information Center	32-42
Voltmeter Display	30, 32

W

Wakeboard Racks	60
Wake Plate (Hydraulic)	57
Walk-Thru Curtain (Optional)	63
Walk-Thru Windshield	57
Warning Labels	10
Warranty	85-87
Washing Your Boat	73
Water Strainer (Optional)	63
Wet Slipping Boots	74
Windshield Care	73
Winterization & Dry Storage	75

